

Valmet

Technical Paper Series

Expansion Of Chemical Recovery Capacity At Södra Cell Värö Mill

Executive Summary

The massive upgrade of the Södra Cell Värö mill in Sweden was recently completed. The mill's capacity has been increased by 64%, with a new maximum at 700,000 ADMT/year of Northern Bleached Softwood Kraft. This new capacity allows development and reinforcement of Södra's market position. Besides capacity, environmental performance has been a key focus area for improvements, including water consumption being significantly reduced through a combination of 100% reuse of evaporation condensates in the mill and the installation of high consistency wash presses in the upgraded fiberline. The use of fossil fuels had already been eliminated through the installation of a new lime kiln, but with the completion of the expansion project the mill has become even more energy efficient. This allows an increase in production of renewable power and biofuels, which helps the surrounding region to further reduce its use of fossil fuels.

This paper reviews changes made to the evaporation and chemical recovery boiler area as part of the project and their role in the production capacity increase, improved environmental performance, as well as increased efficiency of the upgraded mill. Valmet supplied almost all the process equipment for the complete pulp mill. This paper reviews changes made to the evaporation and chemical recovery boiler area as part of the project and their role in the production capacity increase, improved environmental performance, as well as increased efficiency of the upgraded mill.

Introduction

Södra Cell Värö mill in Sweden has recently increased its capacity by 64%, with a new maximum at 700,000 ADMT/year of Northern Bleached Softwood Kraft. Södra Cell is owned by private forest land owners in Sweden and the upgrade was seen as the best way to ensure a high future value of the forests. The higher capacity allows development and reinforcement of their market position with existing customers as well as an expansion into new markets. The reduction in demand for wood chips used to produce printing and writing paper grades offered the opportunity to increase the mill production of Northern Bleached Softwood Kraft (NBSK), which is a higher value product. Planning for the mill expansion project started in 2013. This was followed by approval of the project by the owners' board in February 2014. Valmet was awarded a large contract to look after the process equipment upgrade for the complete pulp mill. Burelle et al (2015) have provided more details on the complete mill upgrade. The project was completed in 2016 with the mill being restarted after the completion of the last major outage that included the final modifications to the recovery boiler and the pulp dryer.

Environmental performance has been one key focus area for improvements. One example is that water consumption has been significantly reduced through a combination of 100% reuse of evaporation condensates in the mill and the installation of high consistency wash presses in the upgraded fiberline. The use of fossil fuels had already been eliminated through the installation of a new lime kiln, but with the completion of the expansion project the mill has become even more energy efficient. This allows an increase in production of renewable power and biofuels, which helps the surrounding region to further reduce its use of fossil fuels.

This paper presents the upgrades in the chemical recovery part of the mill, with special emphasis on the mix of reuse of existing parts of evaporator and recovery boiler systems complemented by new or upgraded process equipment. The boiler capacity was increased by 47% through several large modifications, including major upgrade of the flue gas cleaning. Capacity of the evaporators was increased from 550 to 900 tH₂O/h, and final dry solids (DS) was also increased to 82 % DS. A process for hydrolysis and dewatering of biosludge was included in the evaporation upgrade. Treated biosludge is taken to the evaporation plant and burned in the recovery boiler together with the black liquor (Burelle et al 2016). Production of hot water is now integrated in the evaporation plant and the hot water is led to the mill's secondary heating system and also to Södra's nearby sawmill.

Recovery boiler and evaporator technologies are continuously developing to improve the energy efficiency (Mansikkasalo 2014, Algehed 2002) and environmental performance (Stern et al 2006) of existing mills. Rebuild solutions normally include optimized energy solutions, high availability, and positive impacts on the environment, especially air and water. Fuel price, electricity price, fuel self-sufficiency, and other internal costs need to be evaluated in order to optimize rebuild solutions with regards to energy and environment. As Södra Cell is owned by private forest land owners in Sweden, the upgrade planned for their Värö mill needed to ensure a high long-term future value of the forests. For that reason, the optimum rebuild solutions needed to evaluate and account for costs, availability, and the environment over a long "life cycle" of the mill.

Evaporation and condensate treatment

The challenge

Evaporation plants can be designed to improve the environmental performance of the recovery boiler by producing higher firing solids and creating less variation in the firing solids. Condensate quality from the evaporators can be improved by efficient condensate segregation, integrated condensate treatment systems including production of liquid methanol. Evaporation of various mill effluent streams, such as biosludge, can also improve the environmental performance of the recovery island. With the change in

the mill production capacity combined with the need to increase the product liquor DS for the upgrade of the recovery boiler, the evaporation capacity required an increase by roughly 64%. With the existing train being in relatively good condition, the decision was made to complete the upgrade by reconfiguring the train with the selective addition of new equipment.

Solutions

In today's market, it is not sufficient to look solely at positive impacts on energy, investment, and operation costs. Due to environmental legislation, or corporate values, positive impacts on the surrounding air and water are vital in an optimized solution (Stern et al 2006). Among evaporator solutions for more environmentally friendly operation, the following groups of solutions could be considered important:

- Measures improving the environmental performance of the recovery boiler
- Improved condensate handling (i.e. better overall methanol removal to incineration) in the evaporation plant and better reuse of condensate within the mill
- Evaporation of other mill effluent streams

Evaporation plant solutions for improved environmental performance in recovery boilers include:

- Minimized variations in firing-liquor DS content
- High DS or Super Concentration

In 1986, Valmet pioneered the technology fields of Super Concentration (defined as a DS concentration of 80 % or higher) and Super Combustion (the subsequent burning of the high DS liquor in the recovery boiler). A number of positive effects on recovery boiler were demonstrated at the first full-scale installation at the Aittaluoto mill in Pori, Finland (Stern et al 2006). These included:

- Reduced SO₂ emissions
- Reduced H₂S emissions
- Increased reduction efficiency

In addition to the above-mentioned environmental benefits, Super Combustion also increases steam generation, thus enabling increased output of green electric power (Raukola et al 2002). Valmet is still the leader in high DS concentration, with more than 35 Super Concentrator systems in operation worldwide at concentrations ranging from 80–85 % DS.

To optimize the operation of a recovery boiler, a constant heat input is essential. If variation in the liquor solids content is minimized; optimized operation is easier to achieve (Karlsson et al 2003), contributing to lower levels of airborne emissions. Steadier operation has also been shown to extend the time between shutdowns required to clean the boiler.

In addition to high DS, it is also important to have high availability and reliability of the evaporators, including the ability to effectively wash sodium salt scale with the evaporator train remaining in operation. This scale comes from the precipitation of sodium salts that forms crystals in the liquor on one heating surface when the DS content of the liquor is above their solubility limit, commonly referred to as the critical solids. This task is well performed by the tube element evaporator (**Figure 1**) that has the liquor falling on the outside of the heating elements and the steam / vapor condensing on the inside. Automated washing of the surface is performed by isolating a vessel (or section of a vessel) and evaporating weak liquor, as sodium salt scale is soluble when the DS concentration is below the solubility limit.

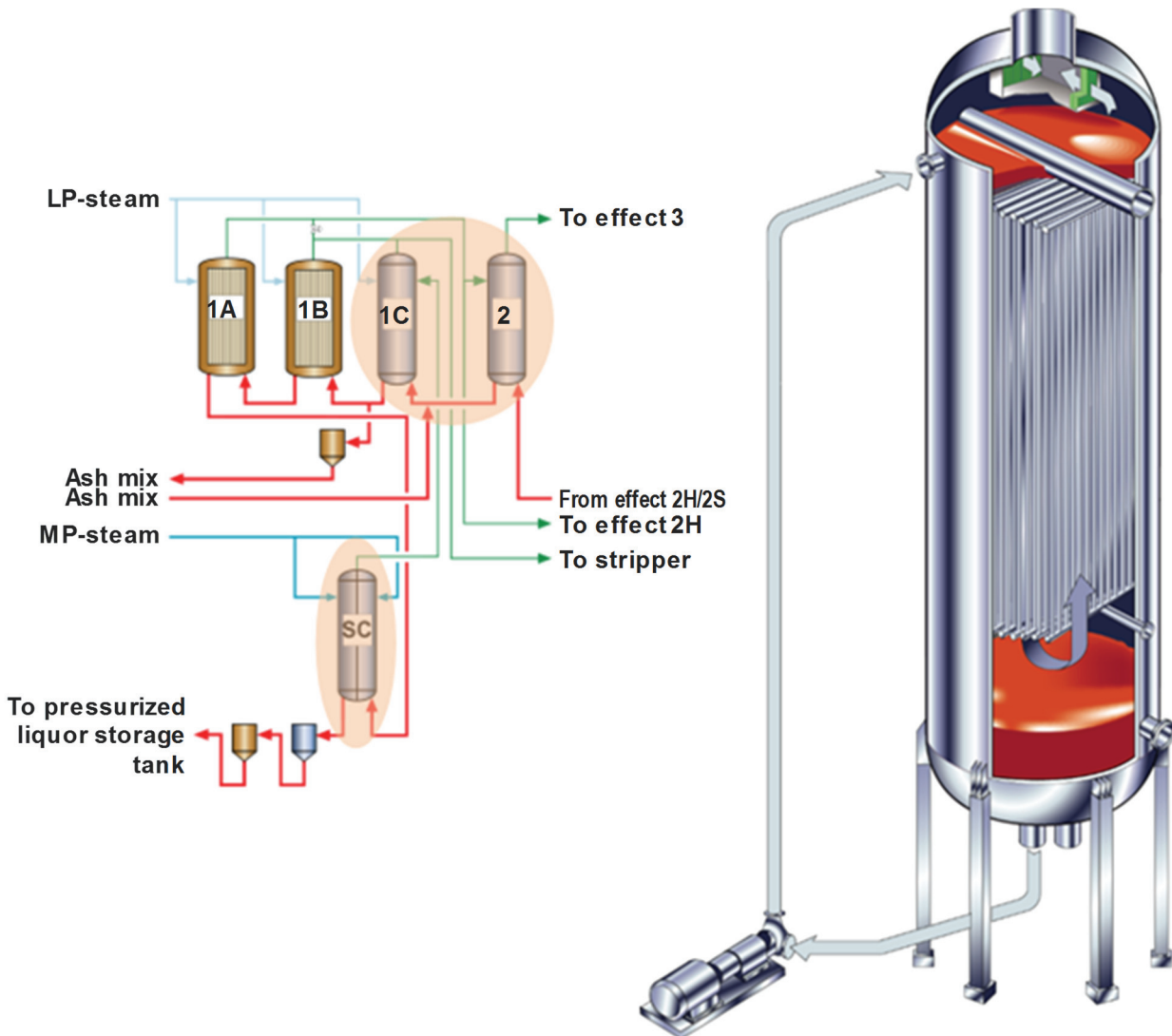

Figure 1. TUBEL (tube-element type) evaporators offer improved washing of scaling on-line (Tikka 2008)

In positions that operate below the critical solids level, standard tube and shell type vessels can be used, in which the liquor falls as a film inside the tubes and the vapor is condensed on the shell side (**Figure 2**). This arrangement allows to have a large amount of heating surface with a smaller footprint. The tall vapor head located at the bottom of the unit is engineered to handle the larger vapor volumes in the lower pressure / vacuum end of the train while providing very good liquor droplet separation to insure no sodium carryover in the condensate.

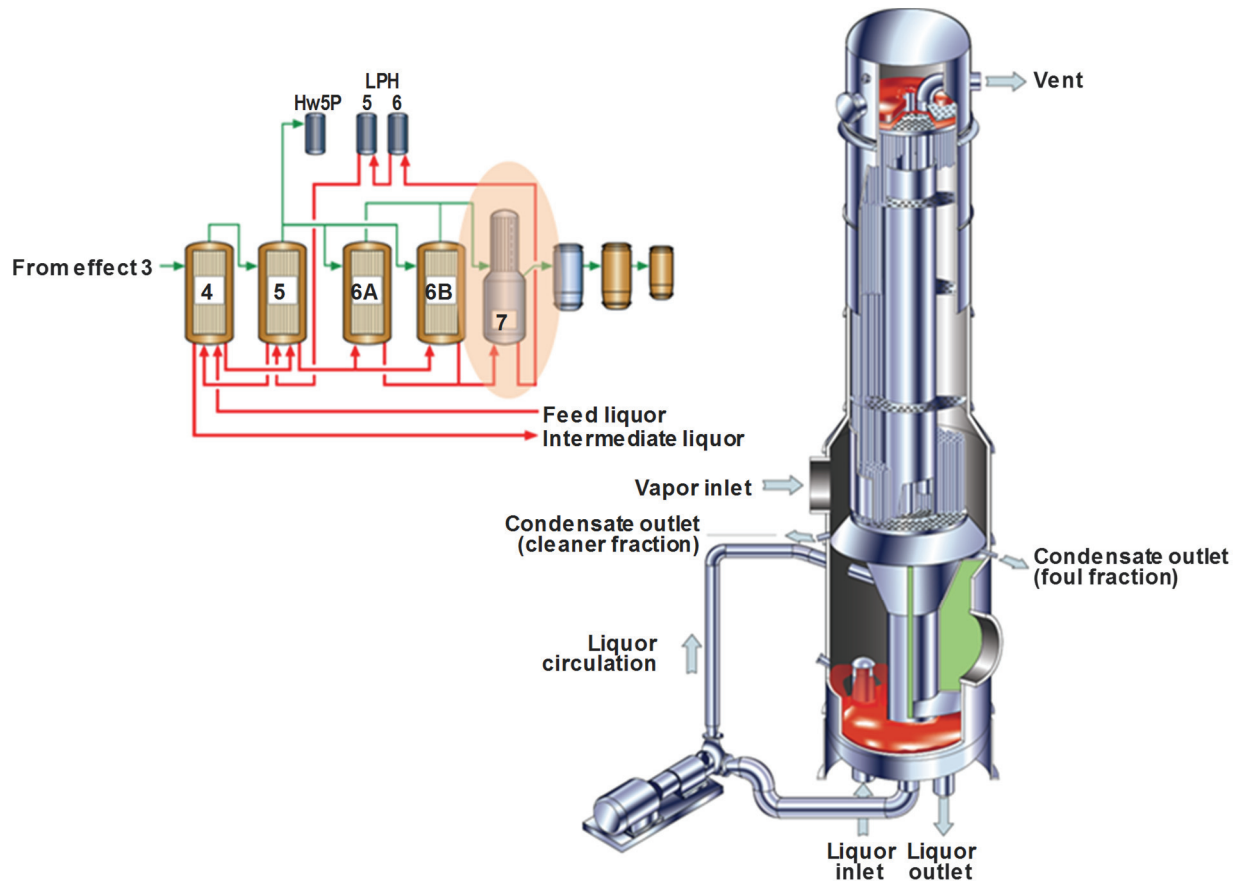

Figure 2. As effect 7 - Tube Evaporator designed for internal condensate segregation (Tikka 2008)

Today's customers require that all their evaporator systems include condensate segregation and treatment for effective mill-specific removal of malodorous substances. Accordingly, evaporators may be equipped with a design for internal vapor segregation, whereby a large part of the contaminants in the feed vapor may be collected in a small condensate fraction (**Figure 3**).

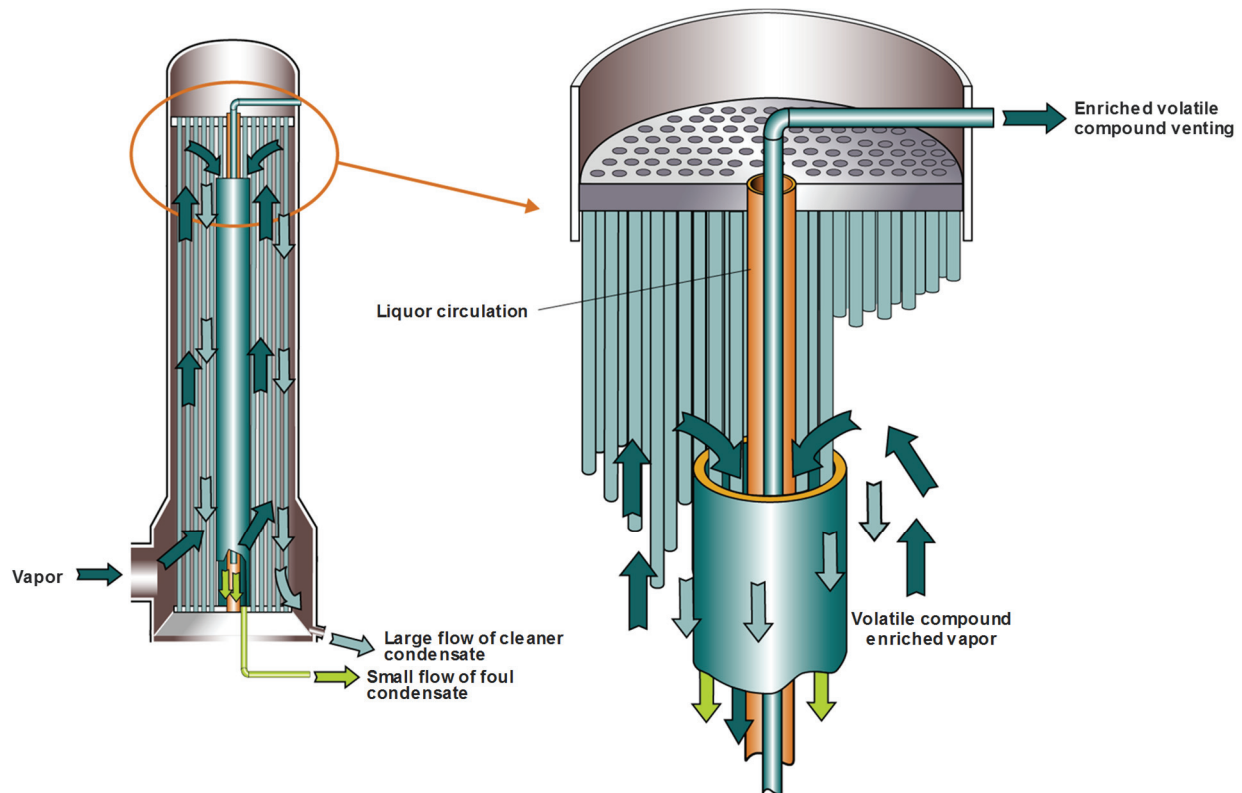

Figure 3. Internal condensate segregation in tube type vessels to produce clean condensates for recycling in the mill (Tikka 2008)

How much "foul" condensate that is formed, depends on the relative heating surface areas in the "clean" and "foul" zones. Quantities of methanol and other volatiles in the vapor that end up in the "foul" condensate fraction are determined by the equilibrium conditions (Redeborn et al 1998).

In modern evaporation plant upgrades, condensate handling is customized for the specific mill, combining a number of measures (Stern et al 2006), such as:

1. A larger condensate treatment plant, such as a high-volume stripper, integrated into the evaporation plant in an energy-efficient configuration.
2. Proper arrangement of the incoming vapor to the evaporator, to ensure good condensate segregation. It is critical that vapor be fed to the lower part of the heating shell.
3. One or more Tube Evaporators in the plant may also be equipped or retrofitted with an internal condensate treatment (ICT) system, in which condensate may be recycled and treated in a "clean stripping" zone inside the evaporator effects (Stern et al 2006).

Clean, intermediate clean, and treated condensate streams from the evaporation plant are typically reused as wash and/or dilution water in the fiberline and in the causticizing plant. The modern evaporation plants are designed not only for concentrating black liquor for combustion in recovery boilers, but also for producing various clean condensate streams that can be reused 100 % in the pulp mill to minimize overall water consumption (Wernqvist 1995).

The project

In case of Värö evaporation upgrade, the existing condensate treatment plant already included a high-volume stripper, which could be integrated into the evaporation in an energy-efficient configuration by adding a falling film type reflux condenser in the evaporation train. To improve the COD removal efficiency, the existing stripping column was completely upgraded, replacing all trays, down-comers, and other internals with a new design adjusted for the high-volume design flow. Baffles and tube pitch selected in the new Tube Evaporator to ensure maximum "stripping" effect and optimal condensate segregation. Since as a large amount of condensate is treated in the upgraded stripping column, ICT was not needed to meet the condensate requirements for recycling in the pulp mill.

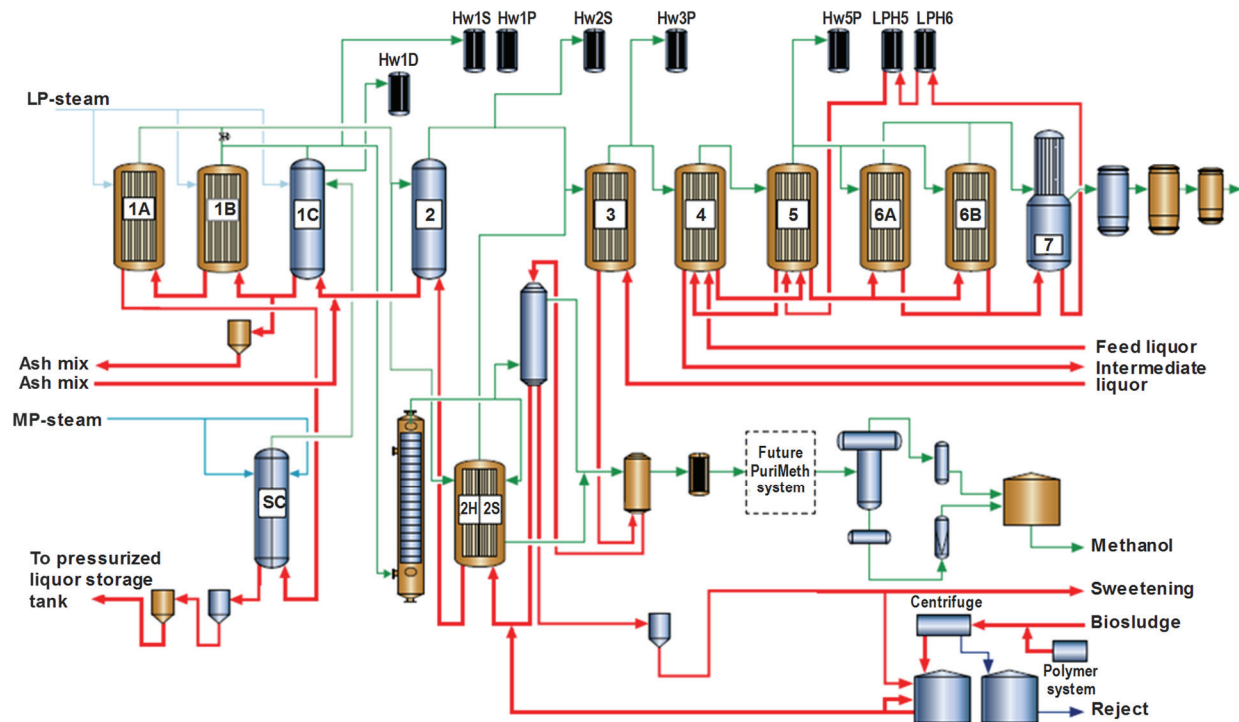

Figure 4. Upgraded evaporators including hot water production system at Värö mill (new vessels shown in blue).

The original plant design for the evaporators was 550 tH₂O/h, but the layout was prepared for an upgrade to 800 t/h. This upgrade carried capacity even higher, to 900 tH₂O/h, and final DS was also increased to 82 % DS virgin - a simplified flowsheet of the upgraded train is shown in **Figure 4**. While existing plant was consisting entirely of lamella type falling film evaporators, the upgrade now included adding a Super Concentrator driven by medium-pressure steam, a concentrator driven by low-pressure steam and a vapor-driven effect 2. These new effects were all of falling film tube-element design with liquor on the outside of the tubes, as shown in figure 1. The existing effects 6 & 7 were set to operate in parallel on the vapor side as effects 6A & 6B. A new falling film Tube-Evaporator as vapor-driven effect 7 and a primary surface condenser were also added. Several heat exchangers were also added to the evaporator train in order to produce hot water at the right temperature for several pulp mill processes and the nearby sawmill.

Evaporators were also integrated into overall mill process by using clean secondary condensate directly at the correct temperature into the bleach plant, as shown in **Figure 5**. Using secondary condensate and white water from the pulp machine instead of fresh water helped to significantly reduce the mill water consumption, the total mill effluent and the steam required in pulp production. Using wash press at all stages in the upgraded bleach plant gives low effluent volume from the bleach plant.

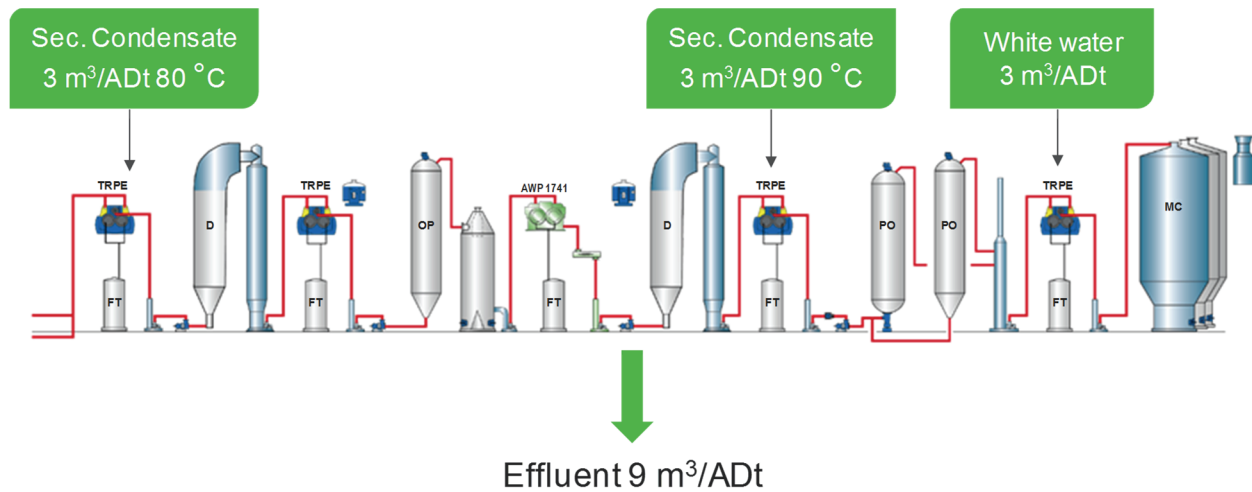

Figure 5. Secondary condensate from the upgraded evaporation plant and white water is recycled in the upgraded bleach plant to minimize Värö mill's overall water usage.

In this type of upgrade, the standard procedure is to use laser measurements of the existing units and import the results together with the new equipment into a 3D-modelling tool. In this way, interferences can be avoided, and piping can be optimized in order to reduce field installation, eliminate unnecessary rework at site and minimize outage time. In a more complex rebuild, such as that for the recovery boiler and evaporators at Värö, using this approach proved to be very valuable (**Figure 6**).

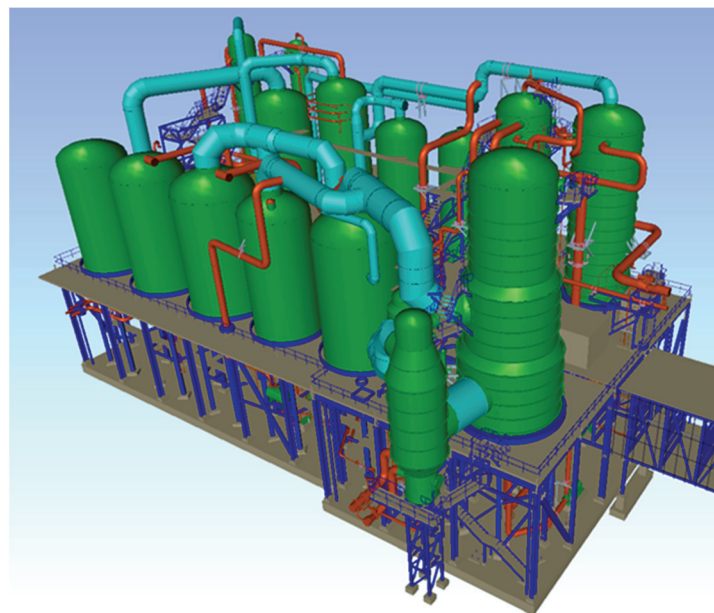

Figure 6. 3D model used for plant detail engineering of evaporation upgrade

A secondary consideration for the project was handling of methanol in the stripper off gases (SOG). Direct incineration of the SOG in either the recovery boiler or lime kiln is possible, but poses, especially in the lime kiln, additional challenges with variations in the methanol and moisture content of the gases. In addition, SOG have to be incinerated as they are produced. By sending the SOG to a liquid methanol plant, it is possible to both reduce the moisture content of the gases and allow for storage of the methanol in liquid form. This provide more flexibility in its incineration. **Figure 7** shows the arrangement of the methanol liquefaction system included in the project along with the integrated decanter for low-quality turpentine (also replacing an existing smaller methanol liquefaction system). Liquid methanol and low-quality turpentine are mixed and incinerated in the recovery boiler. As indicated, the system may be supplemented with a PuriMeth system in the future, with the purpose to open external sale of the industrial quality methanol while also lowering the mill's overall NO_x emissions (Wennberg et al 2017).

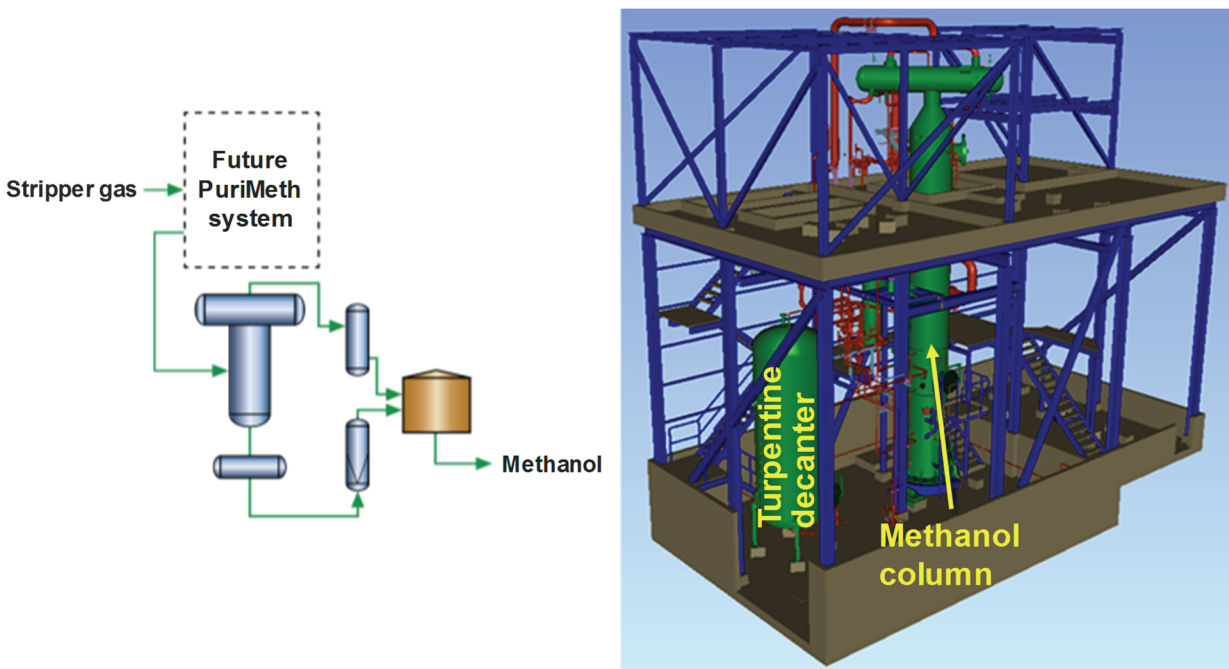

Figure 7. Liquid methanol is produced and mixed with decanted low-quality turpentine for incineration in the recovery boiler

The other system coupled to the evaporator upgrade project was the treatment of biosludge (secondary sludge) for incineration in the recovery boiler after it is treated by a hydrolysis process. Treated biosludge is added to the black liquor ahead of the concentrators. Key benefits of disposing of the biosludge in the recovery boiler (Burelle et al 2016) are that it is more thermally efficient as opposed to incineration in the power boiler (using the steam economy of the evaporators as opposed to the loss of steam generation efficiency in the power boiler) and the handling and disposal associated with composting or landfilling (now banned in Europe).

Figure 8 shows the arrangement of the biosludge treatment system which is located adjacent to the evaporator plant (also replacing an existing significantly smaller biosludge treatment system at the mill), and is designed to treat 21 ton of solids per day coming in at below 1% solids.

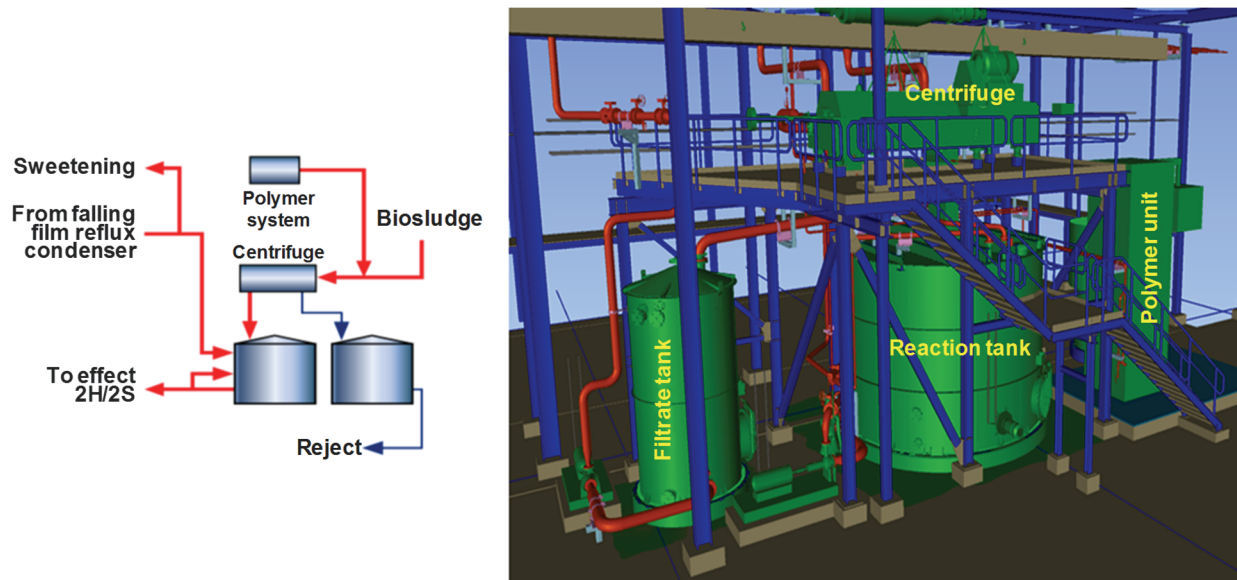

Figure 8. Secondary sludge is hydrolyzed with hot black liquor, in order to evaporate and allow for disposal in the recovery boiler

The outage

The new equipment was largely installed while the mill was in operation. The biosludge treatment system was commissioned and placed in service 3 months before the main outage for the mill upgrade. The tie-ins and the cold commissioning for the evaporator plant, including integrated systems for stripping, liquid methanol production, and hot water generation, were all completed during the main outage in June 2016. **Figure 9** shows the evaporator train before and after the upgrade.

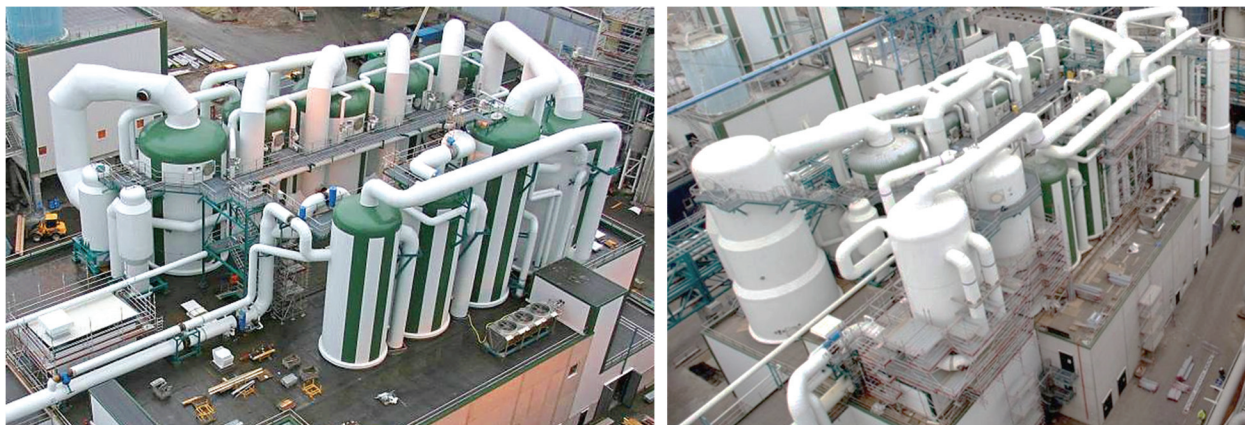

Figure 9. Evaporation train at Södra Värö mill, before (left) and after upgrade (right), with several new white

The results

By raising the final DS, from on average just below 75% before the rebuild, to 82%+ DS, the amount of water needed to be evaporated in the recovery boiler has decreased, meaning that the net increase in steam generation in the recovery boiler is 16 t/h.

Amount of incoming methanol that is removed overall to incineration, via condensate segregation and treatment, is >95% according to design calculations, which is a comparably very good overall methanol removal efficiency for both new and upgraded plants (Stern et al 2006). Measured TOC varying above and below 100 ppm in combined outgoing clean and treated condensate ("KLR90") indicates that methanol removal efficiency may be even higher. Burning of methanol and low-quality turpentine in the recovery boiler has resulted in a net increase in steam generation of 8 t/h.

There is a need of hot water in the pulp mill's secondary heating system and also in Södra's nearby sawmill. By integrating hot water production in the evaporation plant, vapor generated in the plant is used for heating the hot water. The upgraded evaporator plant, including the heat transfer surfaces in the train, was designed to accommodate a wide range of production conditions and seasonal variation in hot water demand. Heat production design for the sawmill system is up to 25MWth and for the process water system up to 20 MWth. So far the demand for heat production has been approximately 13 MWth for the sawmill system and 12 MWth for the process water system.

Recovery boiler

The challenge

The recovery boiler capacity increase required to match the production capacity of the mill was exceptional, having to go from below 2500 tDS/d (5.5 million lb DS/day) to 4000 tDS/d (8.8 million lb DS/d), a 60% increase. The Värö recovery boiler was relatively recent installation and was built with an already relatively high furnace hearth heat release rate (HHRR). During construction, the boiler steel and the drum were located further back from the front wall of the furnace to allow for a future increase of capacity of around 30% by moving the front wall out. As the increase in capacity required was greater than 30%, more sizeable modifications and stretching of the normal design guidelines were required with the upgrade. The capacity upgrade needed to address all aspect of the recovery boiler design, such as furnace size, combustion air system, heating surface in the convective sections, flue gas volume and emissions.

Solutions

Typically, the first parameter considered when considering the maximum capacity of a recovery boiler is the furnace HHRR, which consists of the liquor heat input divided by the furnace plan area.

Figure 10 shows the typical values for the HHRR as well as the value used for this upgrade project. At the significantly higher capacity after the rebuild, the recovery boiler was still predicted to become the new bottleneck for the mill, so the task

was to get the very most of capacity out of the recovery boiler to enable the required mill capacity. Furnace loading became 4.0 MW/m² which, combined with an expected time between water washes at 12 months or more, stands among the highest in the world to date.

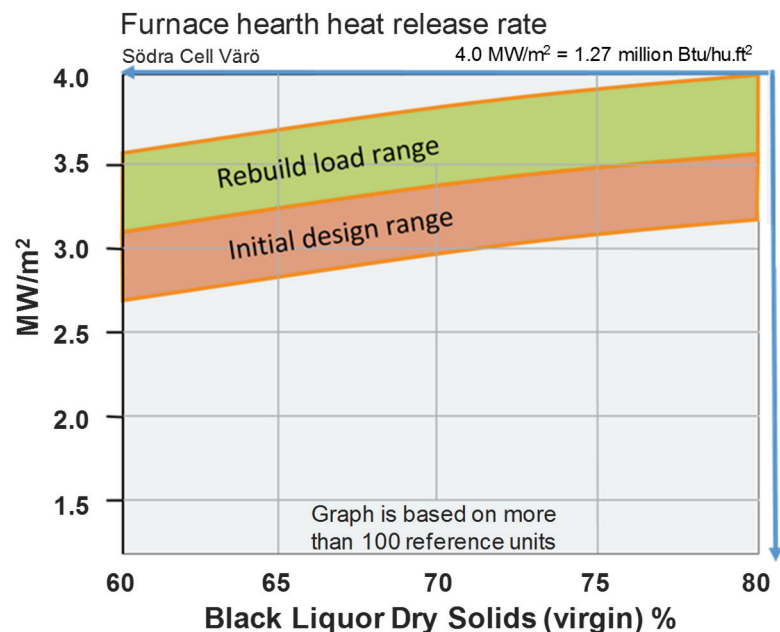

Figure 10. Furnace Hearth Heat Release Rate (HHRR)

As the figure shows, the acceptable value increases with higher liquor DS. This is due to the lower flue gas volume which in turn reduces the rising velocity of the gases in the furnace, increasing furnace residence time and reducing the potential for liquor carry over. Designing for 82% DS was done as much for acceptable furnace HHRR as for increased thermal efficiency of the boiler.

To achieve the acceptable furnace HHRR of 4.0 MW/m² (1.27 MMBtu/hr.ft²), the front wall was moved 2 meters, which was in excess of what was planned as part of the future capacity upgrade allowed for during the initial boiler design. This required considerations of the platforms to realize a good working environment in a contracted area.

The second design challenge was to upgrade the air system to provide the additional amount of combustion air based on the liquor amounts to be combusted while providing the right air distribution to achieve high reduction efficiency and proper bed control, minimizing the carry over and fuming to reduce the potential fouling of the convective sections and to achieve low emissions. The upgrade consisted of a modern 4 level air system. The existing system with numerous of air levels was simplified and easier to tune while minimizing the number of changes to the pressure parts.

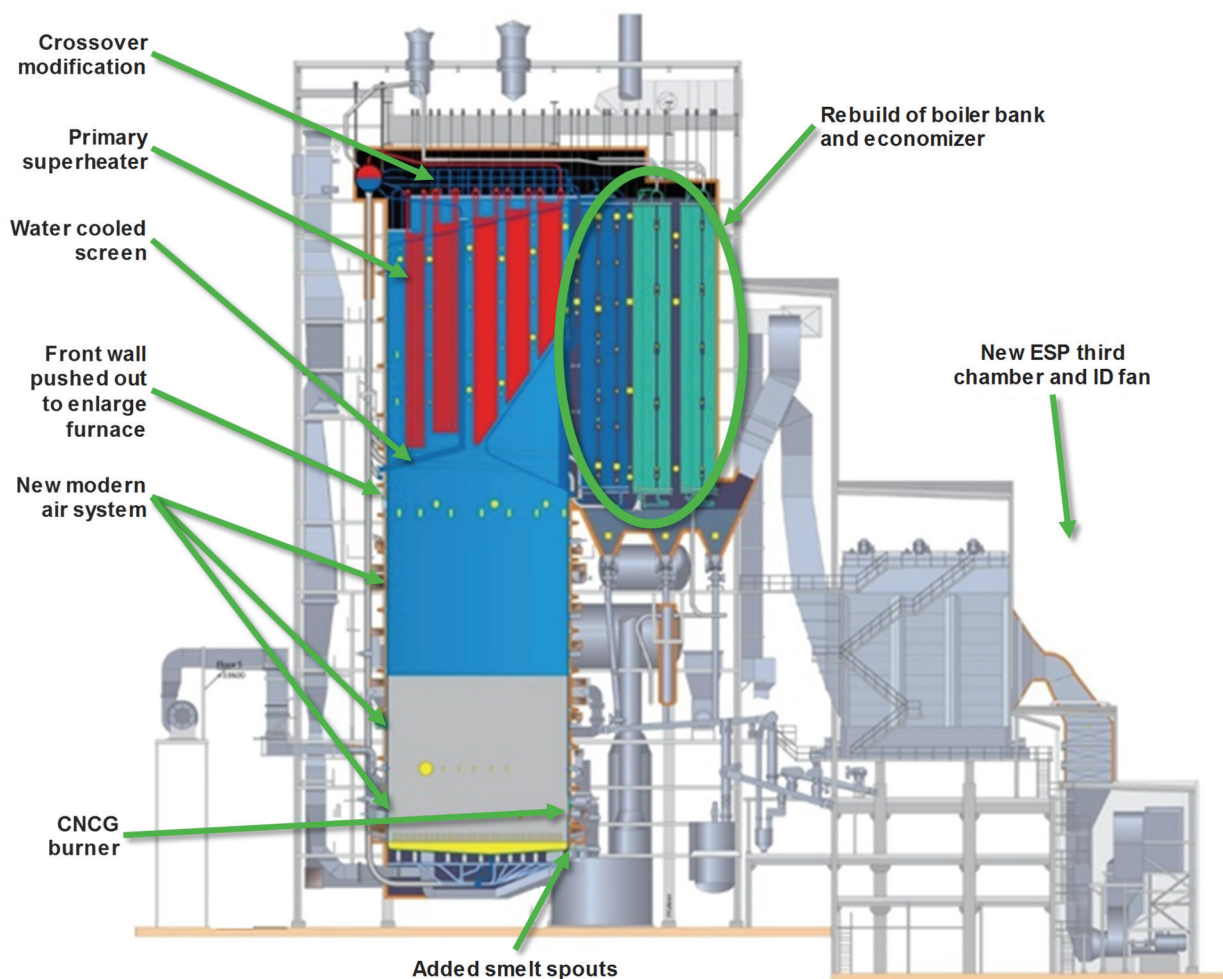

Figure 11. Recovery boiler upgrade

The next challenge was handling the extra steam generation associated with the increase boiler capacity. This required the installation of additional superheater and screen surface as well as modifications to the attemperation system and steam cross-over piping. The additional surface was needed both to maintain the steam temperature at the outlet of the superheater as well as to maintain an acceptable flue gas temperature entering the generating section of the boiler below the melting point of the ash.

The additional flue gas volume required changes to the economizer to maintain the flue gas velocity at an acceptable level and get a reasonable flue gas temperature leaving the boiler to obtain a good boiler thermal efficiency. Due to the space limitation within the building, this was accomplished by providing a new upflow / downflow economizer solution without the traditional idle pass. The flue gas path in the upgraded boiler is downflow in the generating section, upflow in the first economizer bank and downflow in the last economizer bank. Finally, the larger flue gas volume required the addition of a third chamber to the electrostatic precipitator as well as a new ID fan.

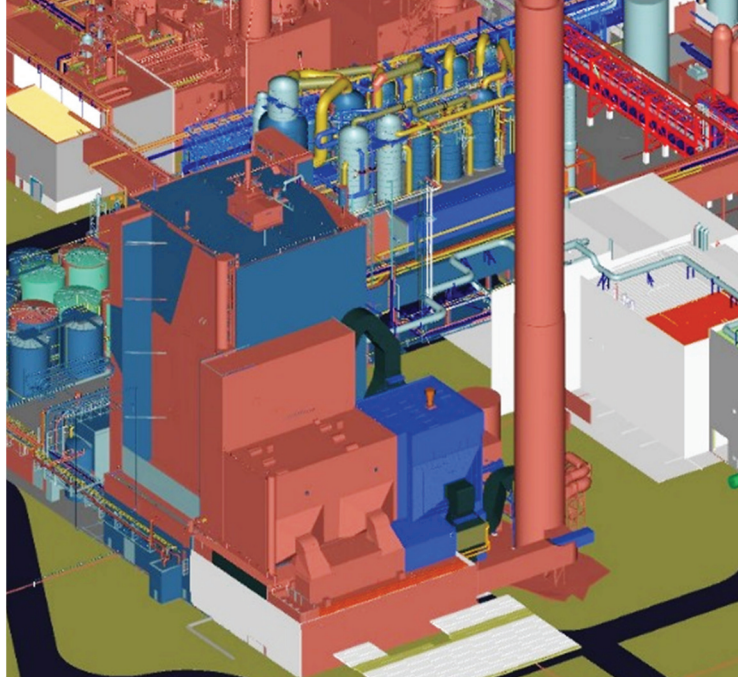

Figure 12. Model of upgraded recovery boiler

Other modifications to the unit included the addition of two smelt spouts, upgrade of existing CNCG burner for higher capacity and a new methanol/turpentine burner. The modifications can be seen in **Figures 11 and 12**.

The project

The boiler upgrade project was done in two phases, the first being some steel and platform modifications carried during the regular annual maintenance outage in the spring of 2015 and the second being the main boiler upgrade outage in June 2016 that corresponded with the upgrade of the pulp dryer and the finalization of the complete mill upgrade.

The outage

The outage started with a cold and clean boiler in May 2016. The outage was challenging, both from a logistical and equipment perspective as a large amount of heat surfaces had to be inserted into the boiler. **Figures 13 to 15** show pictures of some of the installation work.



Figure 13. New heating surfaces waiting to be hoisted into the recovery boiler



Figure 14. The roof of the boiler has been opened and front wall is being pushed outwards using hydraulics.



Figure 15. Despite challenges during the outage, the focus on safety was high.

The results

After the start-up, the recovery boiler was never limiting the production of the mill. The operating performance has been as expected meeting the predicted values and an approved test run showed that steam temperature fulfilled with good attemperation margin, reduction efficiency exceeded 90 % measured, NO_x emissions at 82 to 88 ppm, dry, SO₂ and TRS almost 0 ppm and CO at approximately 300 ppm, dry. The new concept of the economizers does perform well and the flue gas temperature is as predicted. Initial measurements of the new ESP and in parallel with existing filters show values below 25 mg/nm³. The boiler has been easy to operate at the maximum continuous rating and also at a 5% overload.

Conclusion

All given parameters, including information not traditionally shared by the customer, should be evaluated in a plant optimization. With everything taken into account, the evaporators and recovery boiler can be optimized within the context of overall mill upgrade, to meet customer requirements, including optimal energy solutions, the lowest possible environmental impact on air and water, and high availability. The Södra Värö mill upgrade of the recovery island has demonstrated that:

- Increased and more stabilized product solids lower emissions as well as improved the energy efficiency of the recovery island.
- Many different mill effluents can be incorporated in the black liquor evaporation plant to reduce the outflow from the mill and/or allow destruction and chemical recovery in the recovery boiler.
- With hot water production integrated in the upgraded evaporation plant, overall energy efficiency can be increased significantly - here exemplified as hot water that is led to the mill's secondary heating system and also to Södra's nearby sawmill.
- Recovery boiler design upgrades continues to show the potential for additional incremental gains in capacity compared to what was believed to be ultimate limits before.

Acknowledgements

Valmet thanks Södra Värö mill manager Jonas Eriksson who co-authored a referenced early version of this paper, and Värö's Helena Fock who assisted with mill operating data and comments on the text.

References

Algehed, J. (2002): Department of Energy and Environment, Chalmers University of Technology, Ph.D. thesis, "Energy efficient evaporation in future Kraft pulp mills".

Burelle R, Luder K, Lindholm K, Nordgren M & Wernqvist A (2016): Proceedings TAPPI Peers, Jacksonville. "Disposing of secondary sludge (biosludge) in the recovery boiler."

Burelle R, Henderson M, Dahllöf H, Eriksson J (2015): Proceeding Tappi Peers, Atlanta. "Södra Cell Värö mill expansion, making of a state-of-the-art pulp mill".

Karlsson M., Wernqvist A., Wimby M. (2003): Proceedings "36th Pulp and Paper Annual Meeting. ABTCP, Sao Paulo, SP — Brazil. Oct. 2003", "Process dynamics and black liquor optimization of evaporation plants and recovery boilers".

Mansikkasalo J. (2014): Proceedings "International Chemical Recovery Conference 2014", Volume 1, pp. 105-119, "Improving energy efficiency of existing recovery boilers".

Raukola A., Ruhola T., Hakulinen A. (2002): Proceedings "2002 TAPPI Fall Conference and Trade Fair, "Increasing power generation with black liquor recovery boiler".

Stern R., Anängen F., Wernqvist A. (2006): Proceedings 2006 Tappi Engineering, Pulping, & Environmental conference, Atlanta, Nov. 6–8, 2006, "Evaporation system solutions – Energy and the environment".

Redeborn M., Wernqvist A., Ström K. (1998): Nord. Pulp Paper Res. J. 13:3, 172– 179, "Adaptable calculation method for segregation of contaminants in vapours formed from black liquor".

Tikka P. (2008): Papermaking Science and Technology Book 6 (Part 2) Chemical Pulping Part 2, Recovery of Chemicals and Energy. Second edition. Paper Engineers' Association/Paperi ja Puu Oy. ISBN 978-952-5216-26-4.

Wennberg O, Guordon M, Svensson M, Sjödin H, Nordlander T, Brücher J, Blomberg Saitton D (2017): International Chemical Recovery Conference 2017, Halifax, Canada, "Purification of SOG – An industrial demonstration".

Wernqvist A. (1995): Proceedings "28th Pulp and Paper Annual Meeting. ABTCP, Sao Paulo, SP — Brazil. Nov. 1995", pp. 607–621, "On condensates in tomorrow's environmental-friendly Kraft pulping mill".

This white paper combines technical information obtained from Valmet personnel and published Valmet articles and papers, specifically a paper by Anders Wernqvist, Raymond Burelle, Randy Stern, Fredrik Vedin, Carl-Jonas Krus, and Anders Fransson.

Valmet provides competitive technologies and services to the pulp, energy and paper industries. Valmet's pulp, paper and power professionals specialize in processes, machinery, equipment, services, paper machine clothing and filter fabrics. Our offering and experience cover the entire process life cycle including new production lines, rebuilds and services.

We are committed to moving our customers' performance forward.