

## The Total Woodyard

### Executive Summary

Handling of wood for pulp, paper and board manufacturing processes has experienced many significant changes in recent decades due to stricter environmental regulations, raised production capacities and the use of wood from plantations. Consequently, the research and development work has been focused on finding new solutions that best meet changing needs. Significant savings and pulp quality improvements can be obtained when using the latest wood handling technology.

The question is how to process this raw material to make it perfect for further processing, so that a high quality end product will result, while at the same time optimizing the yield of valuable commodities. Valmet Woodhandling is a global operation focusing on wood preparation for chemical pulp mills, paper mills and panel board mills. It offers turnkey projects including process planning, equipment, erection, training, start-up and after-sales services.

Recent efforts have focused on developing ways to maximize process uptime, while optimizing process parameters during debarking and chipping. The main targets for the optimization of the debarking process are to increase uptime and capacity, improve chip quality, minimize energy consumption and maximize raw material yield. A Total Woodyard from Valmet is the best choice for optimization of all parameters of the wood handling process.

## Table of Contents

Background .....	3
Modern wood handling for high quality pulp and panelboard .....	3
Optimizing wood handling .....	4
Chipping minimizes wood losses .....	5
Subsequent wood handling stages .....	5
Significant savings in further steps.....	6
GentleFeed conveyor .....	6
Log debarking .....	7
GentleBarking method.....	8
EasyTyre debarking drum .....	9
EasyFloat debarking drum .....	10
EasyRoll debarking drum .....	10
EasyBarker mechanical debarking.....	10
Debarking drum wear resistance coating.....	11
Chipping.....	12
Camura GS and GSN chippers .....	12
EasyTurn rotating device for chipper disc .....	13
GentleKnife system.....	15
DuraKnife chipper knife.....	15
QuickLock knife fastening system.....	16
ChipQ to reduce chip variation .....	17
Knife position indicator for run-out measurement .....	18
ZeroGap thrust bearing system.....	18
EasyDrive chipping speed control system.....	19
Chip screening .....	19
EasyScreen for effective chip screening .....	20
CSR chip screen .....	21
NanoPlate coating to eliminate blocked screen plate holes .....	21
Chip handling and storage .....	21
GentleStore .....	22
RecAll reclaimer.....	22
Traversing screw reclaimer .....	23
RotaRecAll reclaimer .....	23
Rotary screw reclaimer.....	23
Bark and biomass handling and storage.....	24
WoodSaver roll conveyor system .....	24
Bark Shredder.....	24
Bark Crusher .....	25
Belt Dryer.....	25
Process control systems.....	26
Case Study - Fibria Três Lagoas.....	27
Summary .....	28

## Background

For the North American market, wood handling equipment engineering and manufacturing, as well as processes and sales, are handled in Florence, Alabama, USA. The Alabama manufacturing facility makes whole log chippers and their components.

Valmet's North American Woodhandling Division has grown out of a combination of three companies - Carthage Machine Company, Murray Machinery and Fiber Making Processes (FMP). These companies, each of which is over 100 years old, were acquired or merged during the last few decades. Murray Machinery started production of pulp and paper mill machinery in Wausau, Wisconsin, USA in 1882. Carthage Machine Company started production of chippers in Carthage, New York, USA in 1894. Fiber Making Processes (FMP), Inc. began production of debarking drums in Chicago, Illinois, USA in 1915.

Today, under the name Valmet, we are the original equipment manufacturers for the equipment that was previously sold by these three companies. Among the most well-known products of these companies are the Carthage and Murray whole log chippers, rechippers, sawmill utility chippers, log splitters and rubber tire debarking drums, all of which are still supported. The FMP product line includes various models of debarking drums, deicing systems, log and chip conveyors, slashers and complete turnkey installations.

The wood handling division supplies capital equipment and systems, as well as individual machines and replacement parts, to the pulp, paper and panelboard industries. Our expertise is in the supply of tree-length and short wood debarking and chipping lines, as well as automated chip handling systems. As a part of the Valmet organization we can also offer products such as the GentleFeed™ log infeed systems, chip screens, RecAll™ and RotaRecAll™ chip storage and reclaiming systems, and smart technology solutions (**Figure 1**). The last-mentioned includes the GentleMatic™, VisiBark™, SmartChipping™ and SmartFeeding™ systems.



**Figure 1.** An example of a gentle wood conveyor feeding the debarking process

Valmet can supply virtually any product required in a log or chip handling system. In addition to supplying new equipment for wood handling projects, we also offer equipment modernization and process solutions.

## Modern wood handling for high quality pulp and panelboard

The main objectives in wood handling technology are:

- Removal of bark as efficiently as possible
- Production of uniform chips for pulp digesting
- Minimizing wood losses
- Minimizing environmental impact.

Wood handling requires experience and adequate technology.



Valmet has over a century of manufacturing expertise and can handle all wood handling needs.

Ideally, these objectives can all be met when debarking and chipping are carried out immediately after harvesting. Furthermore, optimum results, both in debarking and chipping, can be best obtained when there is less variability in log length and diameter. Wood with a high oven dry weight, chips from the surface layer of wood, and chips with a high length-to-thickness ratio offer the best pulp quality in the digesting process.

### Optimizing wood handling for a high-quality end-product

The main areas of optimizing are log receiving and debarking, chipping and chip storage (Figure 2). Minimizing wood losses starts at the point of feeding the logs into the debarking process. Dropping the logs into the drum damages the log ends and increases wood losses and the volume of pin chips. Therefore, in a modern wood handling system, the logs are gently fed horizontally into the debarking process. Many wood species coming from forest plantations are difficult to debark, compared to easy-to-debark softwood which was the primary raw material only a couple of

Incoming logs are an investment to be protected during processing.

Quality and efficiency are critical factors when converting logs to chips.

Proper equipment and process design can preserve high value raw materials during the conversion process.

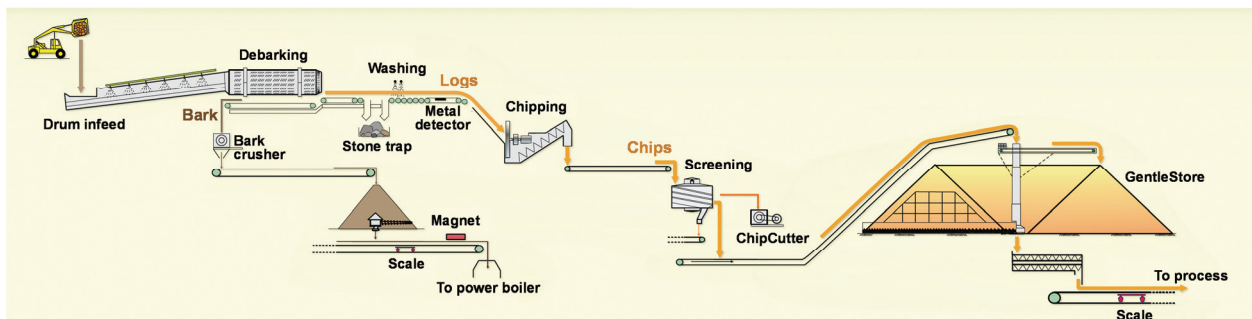

Figure 2. A typical pulp mill wood handling process arrangement

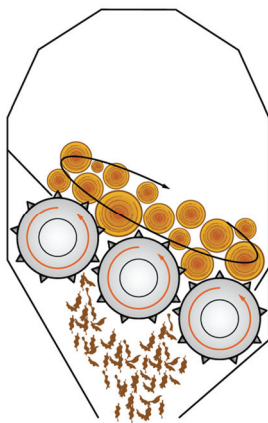

Figure 3. Operational principle of a large capacity mechanical debarker. The teeth of rotating spiral rolls help loosen the bark, which is finally removed by the force of logs rubbing against each other.

decades ago. For example, eucalyptus bark emerges in long strips and mainly follows the logs out of the debarking drum. For this reason, a special bark separation system after the drum is necessary.

Debarking drums (Figure 3) are still commonly used for bark removal at the mill site and they come in a range of structures, with the rubber-tire-supported drum being the most popular. However, in many cases, plantation trees are debarked immediately after felling in the forest using debarking heads mounted on the forest harvester. New mechanical debarking equipment for large capacities can offer an option for debarking of difficult-to-debark species also in frozen conditions.



## Chipping minimizes wood losses

The chipper is the heart of the wood handling process and plays a major role in maximizing the amount of high-quality chips for digesting. A modern chipper is designed to operate with the following criteria:

- low amount of pins and fines
- minimum amount of oversize
- low amount of overthick
- high length-to-thickness ratio.

Correct chipping geometry and knife design are essential in minimizing wood losses and maximizing the amount of accepts (**Figure 4**). Today's mega mills are designed for an annual pulp production of up to two million tons, requiring several wood processing and chipping lines.

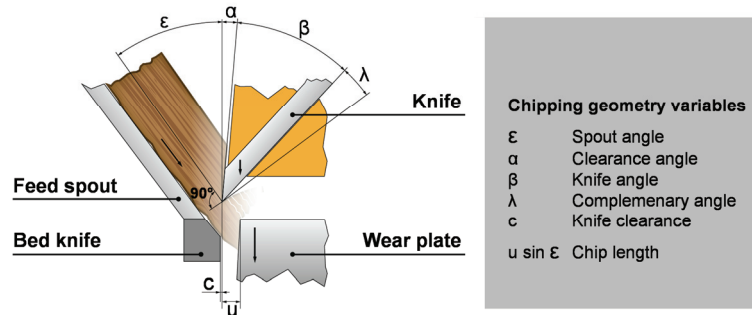

**Figure 4. Chipping geometry and knife design are essential in producing high-quality chips.**

For example, the Suzano Maranhao mill, in Brazil which was completed in 2013, is designed for an annual pulp production of 1.5 million tonnes and will have three wood processing lines, together providing 2,700 m<sup>3</sup> an hour of chips for cooking.

The biggest chippers currently on the market can produce about half that amount of chips an hour. Drop feed and horizontal feed type chippers are commonly used, and the horizontal feed type is especially suitable for longer log lengths, which is typical in North American tree-length chipping.

## Subsequent wood handling stages

It is important to preserve high chip quality in the subsequent wood processing steps, i.e. chip conveying, storage, and screening. Earlier pneumatic conveying systems are no longer favored due to their high energy consumption and characteristic chip breaking, while the belt conveyor offers an economical and gentle transportation alternative.

Many mills still use front loaders for reclaiming open chip storage piles. However, these rough methods easily destroy some of the benefits gained in preceding process stages and increase the loss of total yield.

A modern chip storage system features an automatic first-in-first-out principle, where all chip particles have the same retention time in the pile and where reclaiming takes place automatically and in a gentle operation. The largest individual piles are capable of storing and handling more than 250,000 m<sup>3</sup> of chips. One of the world's largest chip

### Benefits in cooking

Higher yield	0.5-2.0%
Lower kappa	1-3 units
Less rejects	50-85%

### Less bleaching chemicals

Alkali	5-15%
Oxygen	5%
Active chlorine	5%
Higher tear/tensile index	1-2 units

**Figure 5. Obtainable benefits and savings potential in subsequent process stages when utilizing the latest wood handling technology**

storage systems in a single mill is at the April Rizhao mill in China, encompassing five storage piles with one million cubic meters of storage capacity.

### Significant savings in further process steps

Comparison tests with the performance of conventional chippers have shown that significant savings can be achieved in the whole pulping line when using the latest chipping and chip handling technology. In mega-size pulping lines the annual financial savings can be millions of dollars. **Figure 5 (previous page)** shows examples of savings to be expected at a pulp mill when using a state-of-the-art wood handling system.

Now let's walk through the woodyard and review the latest technology used at each process step.

### GentleFeed™ conveyor

In conventional drum infeed systems, using chain conveyors, the plant suffers high wood losses of 3-5%, with low process uptime and high maintenance. To solve these problems the GentleFeed drum infeed system was developed.

GentleFeed is a horizontal drum infeed system (**Figure 6**) which feeds the logs in bundles into the debarking drum without using a chute, as these can cause log breakage. This avoids the wood loss incurred with traditional, inclined chain or belt conveyor systems in which logs are broken or crushed at the junction of the feed chute and the debarking drum.

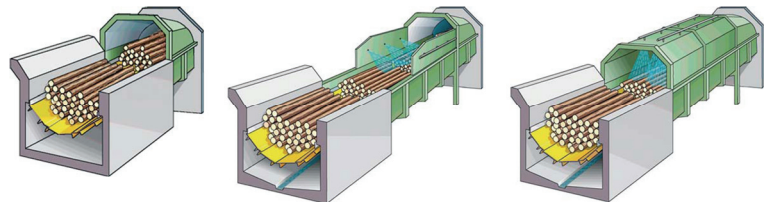

**Figure 6.** The GentleFeed system (left) may be equipped with a washing station (center) or a deicing station (right).

With roller-supported conveying elements there is no need for conveyor chains. The GentleFeed system considerably reduces maintenance due to its non-friction support. The round and smooth bottom of GentleFeed enables the log bundle to start rolling freely at the drum infeed, keeping the logs intact with minimum wood breakage.

To remove sand prior to debarking, the logs are typically washed at a washing station. Thanks to the unique design of GentleFeed there is no point where plugging could take place, which is a common problem with chain conveyors. Due to all of this, the GentleFeed drum infeed system features a uniquely high process uptime. The maintenance costs of the GentleFeed system are lower than those for chain conveyors because it uses heavy-duty steel beams which are more resistant than chains to blows from logs.

Wood loss during drum infeed should be avoided. Conventional drum infeeds generate wood losses of 3-5%.

The GentleFeed conveyor will reduce this wood loss.



The system is not susceptible to jamming and is much quieter than raised conveyors because the logs do not fall through a chute. The innovative chainless conveying principle eliminates unexpected production stoppages such as jammed logs or broken chains that often occur with chain conveyors.

The GentleFeed system eliminates the need for load decks, chain conveyors and feed chutes. Therefore, its service and maintenance costs are extremely low.

GentleFeed is customized to meet the particular needs of each mill. The system is suitable for all kinds of raw materials ranging from shortwood to tree-length wood, softwood or hardwood, tropical or frozen, fresh or dry. In case your raw material contains dirt and sand, a log washing station is supplied to accompany GentleFeed.

In cold climates, round wood must be thawed before stranding (flaking) or chipping. Some high-density hardwood species should also be conditioned for better yield. In the deicing/thawing GentleFeed, log bundles travel through a hot water spray chamber. This method is more effective than conventional heating ponds and more eco-efficient because the treatment water is sprayed and recirculated.

A test run was carried out on the first GentleFeed system in Sweden. On a line feeding softwood less than four months old into a 5 meter diameter debarking drum, wood loss was measured at 1% compared with traditional wood losses in comparable conditions of 2.5% or more.

## Log debarking

In the conventional debarking process, which has been in use in pulp and paper mills over a century, the pile of logs fed into the drum is put in a crosswise tumbling or rolling motion by rotating the drum, which is fitted with log lifters mounted on the inside of the drum shell. While tumbling and rolling inside the drum, the logs rub and hit against each other and bark loosens from the log surface. The drum shell has an essential amount of longitudinal holes (bark slots) through which the loose bark should come out of the drum. In other words, the debarking drum is a combination of a debarker and a bark separation unit.

As a natural development this method has evolved from a batch debarking to a continuous debarking process. In batch debarking, the debarking drum is filled to a high degree while keeping the discharge gate closed and rotating the drum. The batch tumbles in the drum until the logs are debarked, the gate is opened and the logs are discharged gradually from the drum. This method is still used by some mills where the prime target is not to minimize wood loss or to focus on the quality of the end product but rather log cleanliness. This debarking method may cause more than 10% wood loss and a very high percentage of broken logs and broomed log ends.

During the last 30 years, while the required debarking line capacities have risen, drum debarking has been developed into a process where logs are fed continuously into the drum and also discharged continuously from the drum by adjusting the discharge gate position. The aim of this method is to maintain an even discharge rate from the drum by weighing the log flow on the drum

Bark must be separated from incoming logs to access the high quality wood. Imperfect debarking will lose wood, contaminate downstream processes and increase maintenance.

Choosing the correct debarking method for your process will improve wood yield, increase uptime and decrease maintenance.

discharge conveyor via what is known as feedback control. The correct retention time in the drum is achieved by measuring the drum weight and by adjusting the discharge gate position. In the event of an operational disturbance in the process line after the debarking drum, for instance a chipper blockage or a switch-off by the metal detector, the discharge gate is closed and the drum continues running. This method also generates plenty of wood loss due to movements of the discharge gate and may result in an uneven log flow to the chipper infeed, thus making the chipper line susceptible to further disruption.

In the two methods mentioned above the aim is to remove the bark from the drum through the bark slots onto a bark conveyor situated below the drum. To debark wood species with stringy, tough bark which is also difficult to crush into small pieces, separation of the loose bark requires a long debarking drum, although a much shorter drum length would be adequate to debark the logs. In spite of the length of the debarking drum and the number of bark slots, a large amount of loose eucalyptus or acacia bark, for instance, still exits with the logs from the discharge end of the drum onto the chipper line. On the other hand, if the bark slots were larger, the wood losses would be even higher due to the tendency of small wood to go through the bark slots as well. In the chips, this bark is regarded as a serious contaminant unless it can be separated from the log flow.

### GentleBarking™ method

Valmet observed that although the drum of one woodyard was about 35 m long, the bark was clearly removed from the log surface in the first 10 m of the drum length. This provided the impetus to carry out mill-scale studies with various wood species on how the debarking process progresses inside the drum.

In all cases where eucalyptus is debarked in a debarking drum, the bark was removed from the log surface in the first 8-12 m of the drum length. These studies clearly showed that, as far as the pure debarking process is concerned, the remainder of the drum length, the final 15-25 m, was unnecessary and caused wood breakage and unreasonably high wood losses.

When observing the bark flow that passed through the bark slots of the drum onto the belt conveyor, it confirmed the conclusion of ineffective bark separation. This bark flow contained only small fractions of bark and pieces of wood caused by the over-long debarking time.

Good innovations are simple ones, and so it is with GentleBarking (**Figure 7**). The debarking takes place in the drum, but the drum is essentially shorter than those made earlier by the major suppliers in the industry. There are no bark slots in the drum, because the bark is separated in a special roll conveyor after the drum. In addition to a shorter debarking drum, there is less equipment and less civil and electrical work needed with GentleBarking.

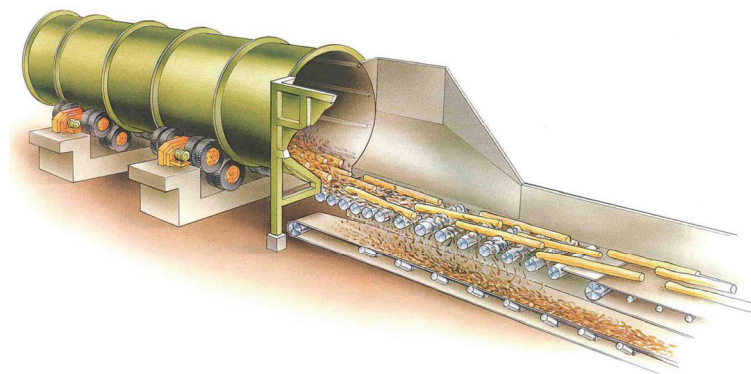

**Figure 7. The GentleBarking process - logs are debarked in a relatively short drum, and bark is removed afterward in a roller section.**



The significant advantage of the new method is a shorter debarking drum allowing a shorter retention time, which means less wood losses and less wood breakage. Another improvement is the even discharge rate from the debarking drum achieved with a fundamental change in the discharge gate operating principle. In the new method, the discharge gate does not function as a slide-gate at all but instead has been replaced with a regulator device, causing minimal interference to the smoothness of the log flow. This means that one substantial source of log breakage and wood loss has been eliminated from the process. The function of the regulator device is merely to set the drum filling degree to a level which corresponds to the prevailing debarking conditions.

Because the loose bark is not separated from the log flow in the debarking drum, the drum shell has no bark slots. This means that the bark chutes and bark conveyor under the drum are no longer needed and the elevation height of the entire debarking line can be reduced by several meters. This brings substantial savings in construction costs and space requirements, which improves and facilitates the utilization of space in the area.

In short, Valmet's new debarking method results in less wood loss, better chip quality, lower operating and maintenance costs and higher uptime. Furthermore, the total investment cost of the system is much lower than that of the present conventional methods.

The Valmet debarking drum product range also includes the EasyTyre™, EasyFloat™, and EasyRoll™ debarking drums as well as a steel roller supported debarking drum, all with special features to meet different customer needs. Their easy and reliable operation is proven by over one thousand successful installations worldwide. In fact, many of the debarking drums we supplied over thirty years ago are still running smoothly today!

### EasyTyre debarking drum

EasyTyre is a rubber tire-supported debarking drum (**Figure 8**), which combines high capacity with easy and reliable operation. EasyTyre provides optimal bark removal with minimum wood loss. Its design also ensures effective bark separation prior to the chipping process. EasyTyre features an ideal support and

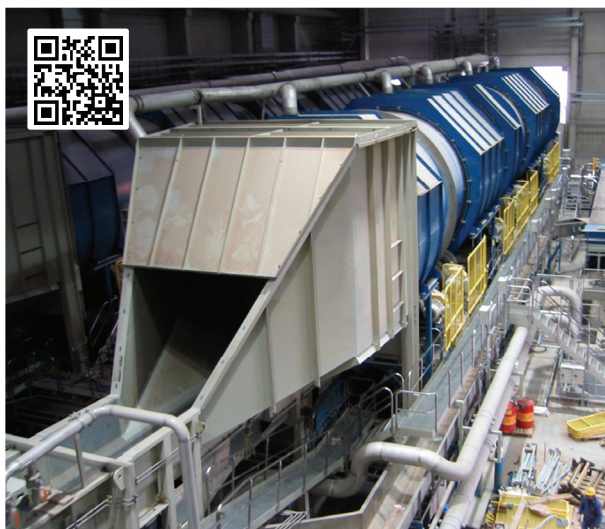

**Figure 8.** EasyTyre is an easy-to-operate, high capacity rubber tire supported debarking drum.

drive system using heavy-duty standard rubber tires. This enables remarkably easy maintenance, which is as easy as changing the tires on a truck.

Optimized tire loads and location ensure a long service life and effective utilization of the drum shell. The elasticity of the rubber tires minimizes vibration and shock loads against the foundation and drum shell.

The drum can be transported in pieces, which makes on-site assembly possible. The support design enables the use of the existing foundation when replacing any kind of debarking drum.

## EasyFloat debarking drum

EasyFloat is a hydrostatically supported debarking drum (**Figure 9**), which combines high capacity with easy and reliable operation. EasyFloat provides optimal bark removal with minimum wood loss. Its design ensures effective bark separation from the logs prior to the chipping process. High reliability of the drum is guaranteed by hydrostatic support bearings enabling high static and dynamic loads.

The large drum size enables high capacity debarking in a single line. This feature minimizes total investment costs. Thanks to an ingenious supporting system with an oil film between the support ring and the bearing shoes there is no mechanical contact and no wear in the supporting system.



**Figure 9.** The EasyFloat debarking drum is hydrostatically supported and provides optimal bark removal with minimum wood loss.

## EasyRoll debarking drum

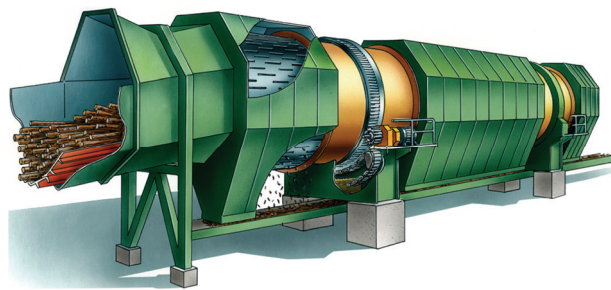

**Figure 10.** The EasyRoll debarking drum is a multi-roller supported drum with high reliability and capacity.

EasyRoll is a multi-roller supported debarking drum (**Figure 10**), which combines high capacity with easy and reliable operation. EasyRoll provides optimal bark removal with minimum wood loss. Its design ensures effective bark separation from the logs prior to the chipping process. High reliability of the drum is guaranteed by an ingenious multi-roller support system balancing high static and dynamic loads.

EasyRoll's large drum size provides high capacity debarking in a single line, for low total investment cost.

## Efficient mechanical debarking with EasyBarker™

The debarking process, resulting in logs of the best possible cleanliness, is essential for a high quality end product in the pulp, paper or panelboard mill. The EasyBarker (**Figure 11**) successfully combines high capacity, excellent debarking performance and robust design. It has efficient bark removal and provides advantageous pretreatment cutting bark in smaller pieces and so easing its

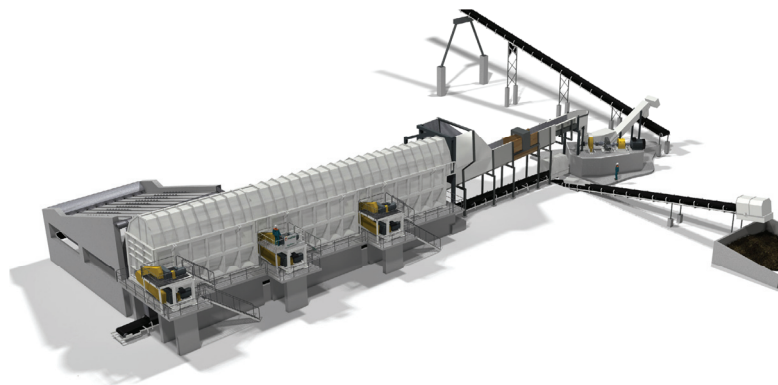

**Figure 11.** With EasyBarker bark may be collected and conveyed via a bark shredder and bark storage to the energy plant.

further processing. EasyBarker is a powerful mechanical debarking system for logs especially in applications where bark cannot be easily removed like:

- Logs with stringy bark
- Frozen logs (no need for deicing)
- Small diameter logs
- Crooked logs

Efficient bark removal in all conditions, especially with stringy bark, is very important for further processing. EasyBarker is designed to ensure efficient bark removal in challenging conditions where bark removal using conventional drum technology is difficult (due to wood characteristics or cold climate without the deicing process).

Worldwide experience from the pulp, paper and panelboard industry and knowledge gathered over 60 years was capitalized in the development of the EasyBarker. This allows us to offer a long service life through a superior combination of reliability and low maintenance.

### Debarking drum wear resistance coating

VAL1 MX™ (Figure 12) is an advanced ceramic composite to protect the debarking drum cell from severe abrasive conditions and chemical corrosion. Touch resin structure resists thermo-chemical shocks. Outstanding adhesion results in reliable performance.

With VAL1 MX coating, logs can be debarked with lower filling degree and with lower rotation speed, which reduces wood loss. Debarking is caused by friction between logs. VAL1 MX ceramic reinforcement increases the friction while debarking to increase the debarking efficiency.

VAL1 MX has been developed to resist shocks and to stand constant hits caused by debarked logs. The composite is highly reinforced with ceramic beads and flakes for resistance to severe sliding abrasion with impact forces.

VAL1 MX is a long-term solution against debarking drum wear which increases debarking efficiency. The coating is sustainable – there is no need to ever replace it.

The VAL1 MX coating thickness varies between 6 to 10 mm, and was measured at over 6 mm after 18 months of running time. The coating is recoatable, which makes it a long term solution against wearing.

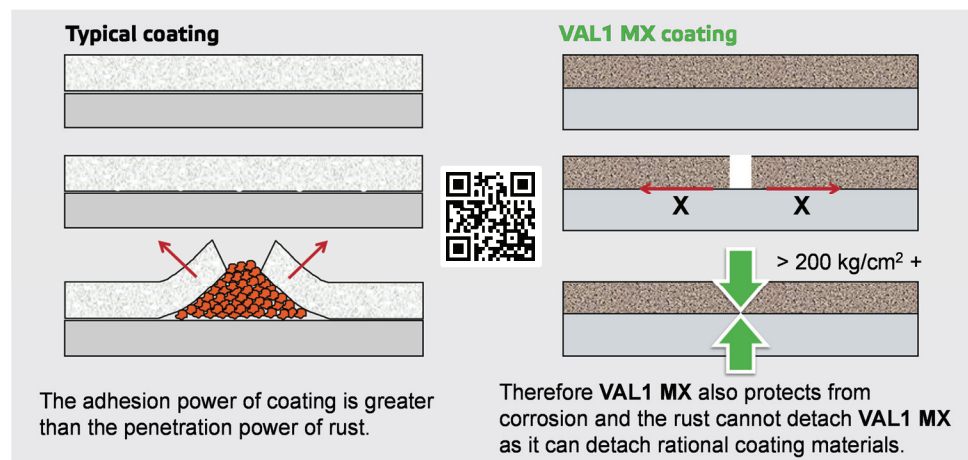

Figure 12. VAL1 MX coating resists corrosion.



## Chipping

Chip quality is the most important factor affecting pulp quality and total economy in the paper making process. The Camura GS™ and Camura GSN™ chippers inherited most of their chipping geometry from the Rauma GS chipper. The present outstanding design is the result of over 200 years' combined chipping experience gained from Rauma, Carthage and Murray chippers. The Camura GS and GSN chippers offer the benefits of sixteen patented features.

### Camura GS and GSN chippers

Thanks to its optimal chipping geometry and back discharge of chips, the Camura chipper (**Figure 13**) produces thin homogeneous chips with a minimum amount of fines, pins, and overthick and oversize fractions. Another important factor affecting chip quality is the optimized control of logs and stable chipping in the direction of the fiber. The infeed spout and ingenious bed knife design ensure that the logs are securely positioned and aligned against the spout bottom and bed knife even at high capacity.

Revenue is generated primarily by creating consistent high quality chips at an appropriate capacity level while ensuring operator and equipment safety.

Poor knives, inadequate or inflexible design and unsafe operating procedures will decrease revenue.

Well-designed chippers and auxiliary equipment maintain safety and chip quality.

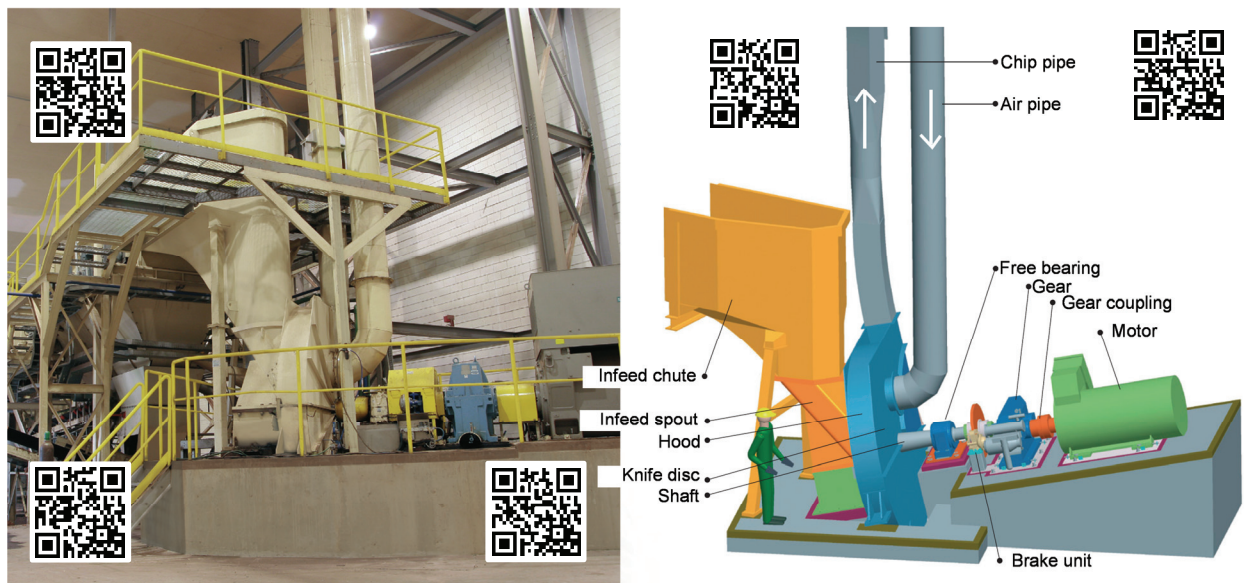

**Figure 13.** The Camura GSN chipper can be gravity (pictured) or horizontal fed and has the widest infeed spout currently available.

### High capacity

The main factors in high capacity chipping are an even log feed rate, a wide infeed spout and a large number of knives. The Camura chipper has one of the widest infeed spouts on the market, specially designed for multiple log chipping. The spout dimensions give both the extra width and height essential for high capacities with small or large logs and for the reduction of log jams. The ingenious spout design also ensures perfect log guidance for optimum chipping even with a single log.



## Durable and flexible design

Valmet has supplied well over 2000 large chippers to date, which is half the entire number of disc chippers for the global fiber processing industry. This has given us valuable insight into chipper durability in all conditions. The heavy-duty Camura chipper offers a long service life with a combination of high reliability and low maintenance.

The chipper consists of an infeed spout, knife disc with shaft, bearings on both sides of the knife disc, hood, frames and drive unit.

The chipper can be either gravity or horizontally fed. The gravity feed chipper is suitable for log lengths of up to 7 meters (23 feet). For longer, tree-length logs the horizontal feed chipper is used. The bottom of the gravity feed chipper spout is covered with wear-resistant hard welding. The horizontal feed chipper spout is equipped with replaceable wear plates.

The precision-machined knife disc is manufactured from high quality, forged steel plate. All areas exposed to wear are covered with wear-resistant replaceable parts. The hard-faced heavy duty wear plates, knife clamps and bed knives are made of special steel for maximum wear resistance. The segmental wear plates are adjustable for easy change of chip length. This is beneficial when adjusting chip quality for various weather or material conditions.

Camura GS features minimum knife clearance along the entire chipping width thanks to a ZeroGap™ thrust bearing and an extremely robust shaft assembly. The smaller knife clearance ensures better chip quality. The adjustment of knife clearance is made by moving the bed knife. The knife disc is in a fixed position.

The gravity feed chipper drive unit is usually located on the front. In the horizontally fed chipper the drive unit is located on the back. The drive unit consists of a squirrel cage motor, flexible coupling, foot-mounted gear reducer and gear coupling. The chipper is equipped with a disc brake assembly. Alternative drives are twin motor, synchronous motor, slip-ring motor or the frequency controlled EasyDrive™ system.

The chipper can be equipped with a conventional, GentleKnife™ or DuraKnife™ system. The conventional knife system utilizes 12.7 mm (1/2") thick knives, which allows multiple grinding, resulting in low knife costs. Knife width adjustment is usually performed with adjusting screws. The patented GentleKnife system is based on regrindable twin-edge knives. The special features of the GentleKnife system mean that the knives stay sharp longer, which extends their lifetime, thus increasing the uptime of the chipping process. The GentleKnife knife holding assemblies are engineered for easy fine-tuning of chip quality. Combining a conventional knife system with the special GentleKnife features results in the DuraKnife.

The Camura chipper is designed for back discharge. Bottom or blowing discharge is available on request. The chipper hood is equipped with a maintenance sector for easy accessibility during knife change.

## EasyTurn™ rotating device for chipper disc

One of the operations containing risk in the wood handling process is the work involved in changing chipper knives. To make sure that chip quality remains the best possible, chipper knives must be kept in very good condition.

When changing the knives, the chipper disk is normally turned to the correct position manually. Turning a disk, which weighs up to 15 tonnes, creates so much kinetic energy that there can be the risk of injury. Turning the disk manually also requires a lot of physical force, which can be a risk factor in itself.

For this reason Valmet started to look for solutions for further maximizing safety at work. We studied and tested various alternatives that would prevent any accidents in knife-changing work. Finally, the best solution turned out to be the product that was recently released on the market under the product name EasyTurn.

The positioning of the disc chippers is facilitated by EasyTurn (**Figure 14**), which gradually shifts the chipping disc when the knife is changed. With user-friendly EasyTurn, safety is improved while knife changing time is reduced.

The EasyTurn device is mounted between the motor and the chipper disk and it features variable speed drive and a drive wheel. The drive wheel can be pushed pneumatically onto the chipper's break disk to turn the chipper disk.

The chipper disk is remotely rotated to a correct position. Knife positioning is made easy by using the joystick to rotate the chipper disc and adjusting the laser beam to point to the knife positioning mark. EasyTurn is suitable for all Camura, Rauma and Carthage chippers equipped with disc brakes.

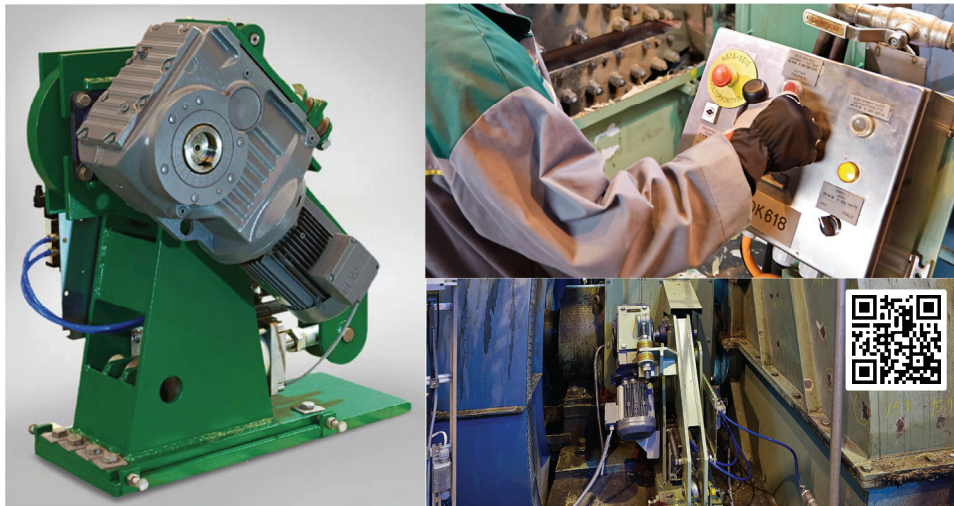

**Figure 14. EasyTurn is the safer, faster way to change chipper knives.**

### Operation experience of EasyTurn

The experience gained with EasyTurn installations so far has been extremely positive. Just recently EasyTurn systems were installed for two Valmet chippers at a customer mill.

Every day the

equivalent of 140 tandem trailer-loads of logs arrive at the mill. All the wood raw material for the pulping process passes through these chippers. To keep the chippers continuously in top condition without risking occupational safety is a challenging job. The knife change operation on both chippers is now carried out safely with the help of EasyTurn.

Experience shows that, often when new methods are introduced, some people would rather do their job the old familiar way until they get used to the new one. However, at this mill with regard to EasyTurn, all operators have started to use this new method from day one. The safety statistics from the installations in operation show that there have been zero injuries related to changing chipper knives since the introduction of EasyTurn.

## GentleKnife System

Premium chip quality is fundamental for producing high quality pulp and paper. Apart from wood quality, it is the chopper, and especially its knife system, that has the most significant influence on final chip quality.

Valmet has supplied more than half of the entire number of disc chippers in the world. We lead the industry in terms of research and development, operating principles, engineering and ultimately, the construction and maintenance of high quality chipping equipment. Our analytical approach to fiber technology provides our clients with significant improvements in overall chip quality, spanning all sectors of the pulp, paper and board industries.

Valmet has developed a superior knife system which greatly improves chip quality. We have combined space-age material technology and unique manufacturing methods to design GentleKnife (**Figure 15**). As a result we can now offer a thinner, sharper, more durable knife than any other system available on the market today.

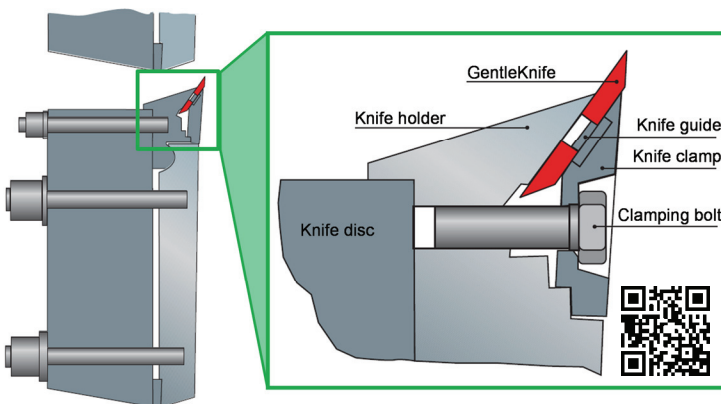

**Figure 15.** The GentleKnife knife holding assemblies may be engineered to suit each individual application.

### Intermediate chip handling

Chips cut by GentleKnife are very durable, and maintain their high quality composition even during intermediate handling, such as transportation and storage, which often damages chips. In the case of chippers with blowing discharge, chip quality improves essentially because the correct cutting technique of GentleKnife also makes them more resistant to the effects of chip blowing.

### Reduced power consumption

Chipping with GentleKnife requires less force, and thus uses less energy. This results in a decrease in both energy consumption and mechanical strain on the chopper itself. Energy consumption variations, typically caused by the chopper itself, are therefore significantly decreased.

### Increased production time

Substantial increases in chipping volume can be realized - even double that of traditional knives - due to the prolonged, consistent sharpness of GentleKnife. This results in fewer knife changes and a reduction in downtime. A single operator can change knives easily, quickly and efficiently. The GentleKnife knives are supplied ready sharpened for use, eliminating the need for knife grinding.

### DuraKnife chipper knife

DuraKnife is a patented chipper knife which can be used in practically all disc chippers. It is custom-made to meet a customer's requirements in existing conditions. A sharp and strong DuraKnife ensures

constantly high chip quality and longer change intervals for the knives, which improve the productivity of the chipper considerably.

The sharpness and durability of DuraKnife (**Figure 16**) are based on a special heat treatment for the knife material and also on the finishing of the knife edge, both of which help to make a sharper and stronger knife. This also means that a DuraKnife knife edge stays sharp longer, resulting in the constant and steady production of high quality chips.

Experience indicates that knife change frequency of a softwood chipper with 12 knives is 6,000-8,000 tons and that of a softwood chipper with 15 knives, 8,000-10,000 tons.

Tests prove that the lifetime of the DuraKnife compared with a traditional knife is about double. When dry and hard eucalyptus wood was chipped in Finland, tests proved that 2,721 tons could be chipped with a 12-DuraKnife chipper. This exceeds the normal knife change frequency of 1,000 tons by a significant amount. This allows longer knife change intervals, reduces downtime and results in improved productivity.

### Results at a pulp mill in northern Finland

"We have two RR (Valmet) 15-3300 chippers at our mill with Valmet's DuraKnife chipper knives. We have chipped continuously for three days and nights and the knives remained sharp all the time. Our production record is 15,000 tons softwood without knife change.

The amount of fines maintains moderately stable. When the knife dulls it does not have a tendency to bend at the knife tip meaning good pulling of the chipper. Chip quality has been good.

Toughness of the knife has been significantly improved. The new knife remains intact even if sometimes we are not chipping only wood. During the last 12 months of production the knives have proven to be of good quality under all circumstances."

### QuickLock™ knife fastening system

Valmet's innovative knife fastening system QuickLock differs fundamentally from traditional systems. A totally new approach has resulted in an ingenious knife fastening system, which gives higher chip quality and easier operation as well as considerable time saving during a knife change.

QuickLock knives are fastened using a revolutionary new technique, which makes knife change both simpler and quicker. This innovation eliminates the time consuming work of cleaning, loosening, fastening and checking the torque of many knife bolts. There are no slots on the disc face, providing an even surface against the logs, which results in a smaller amount of fines and pin chips.

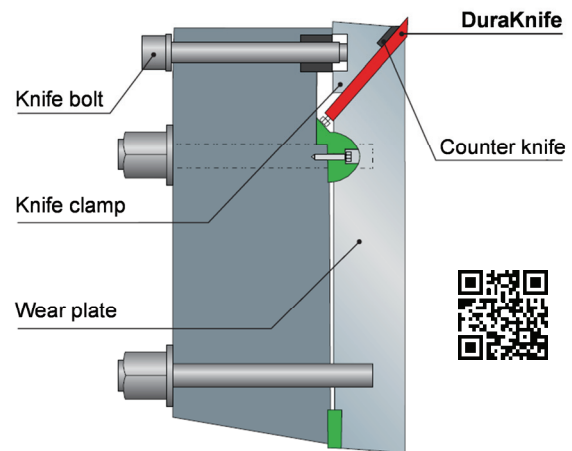

**Figure 16.** According to one customer who uses Valmet's DuraKnife on their main chippers and short wood chipper, "We have tested other supplier's knives, but have been disappointed with the heavy maintenance required and therefore we are continuing with Valmet."



To change the knife, just loosen one bolt, which releases the entire knife clamp. After the knife is changed, simply fasten the same bolt to close the knife clamp. The bolt can be loosened and fastened either manually with a wrench or automatically using an EasyTurn rotation device and a remote-controlled EasyTool™, which is specially designed for the purpose.

Benefits of QuickLock (Figure 17):

- Saves time, increases operating time
- Quick and easy knife change
- Suitable for both conventional and turntable knives
- Reliable and uniform fastening power
- User-friendly knife change
- Higher chip quality



**Figure 17.** The QuickLock knife fastening system saves time. The one-bolt system requires only 15 minutes to change 15 knives, compared to 50 minutes for a traditional system with turntable knives.

## ChipQ™ to reduce chip variation

Does your fiber process differ annually? ChipQ is the development agreement that solves the problem right at the beginning of the fiber-making process – in the woodyard. Chip quality has high annual variation because of changing wood properties. The target of ChipQ is to minimize these differences and adjust chip quality to the level where your process is operating at its best.

The ChipQ development agreement for wood handling provides for process optimizing planning as well as replacement of all worn parts in the chipper. With ChipQ, Valmet provides custom-made chip quality depending on a customer's process equipment and requirements. The primary target of the operation is to optimize chip quality and minimize wood losses in screening. The overall benefits from ChipQ (Figure 18) include:

- Reduces wood losses from screening and debarking
- Reduces 0-mass production and chemical/energy consumption (lower fines content), decreased wood consumption
- Reduces raw material based downtime in processes down the line
- Higher chip density improves packing degree in processes down the line enabling higher capacity
- Enables more uniform thickness and therefore more uniform pulp quality – lower Kappa variation

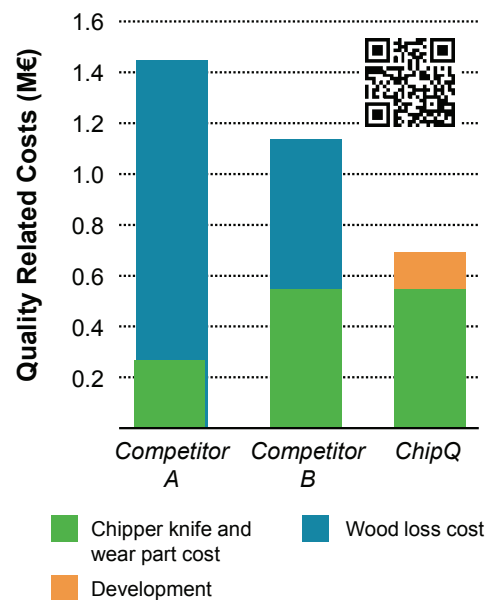

**Figure 18.** Chip quality related costs decrease substantially when using ChipQ optimization.

## Knife position indicator for chipper knife run-out measurement

The portable knife position indicator (**Figure 19**) is designed for easy and contact-free measurement of chipper knife run-out. It finds the highest knife and measures the run-out variation between the knives as an alternative to manual gauge measurement.

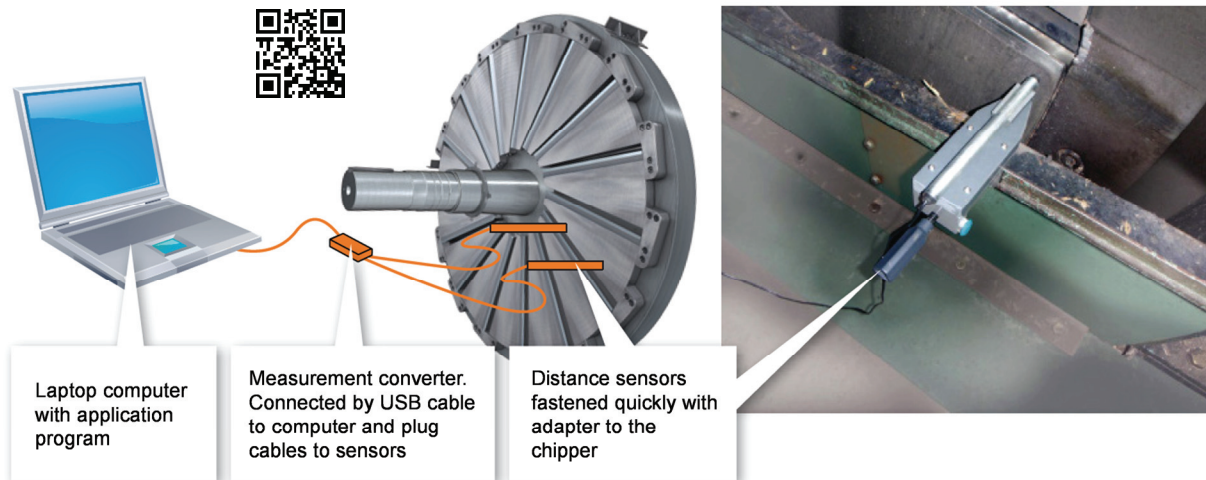

**Figure 19.** The knife position indicator uses non-contact sensors to measure the position of each chipper knife during a service rotation of the disc.

The measurement is carried out during the service rotation of the chipper disc. The knife position indicator records the position of each chipper knife, providing immediate feedback to indicate the pocket position of the high knife and its relative position to the other chipper knives. Measuring is carried out simultaneously on the inner and the outer circumference of the disc providing a quick, consistent and accurate read-out. The benefits include:

- Quick and accurate non-contact measurement
- Eliminates human error in knife change
- Suitable for all types of knives
- No mechanical installation needed
- Simple to use
- No special maintenance needed

## ZeroGap thrust bearing system for disc chippers

To obtain high quality chips requires minimal and constant distance between the knife edge and the bedknife. Conventional bearings allow for excessive axial motion. ZeroGap (**Figure 20, next page**) is a bearing design that neutralizes axial motion, thus minimizing shives and fines from the chips.

ZeroGap can be installed in all chippers with conventional bearings. The benefits include:

- Minimizes knife clearance
- Fewer oversized chips
- Fewer shives
- Constant knife clearance gives uniform high chip quality

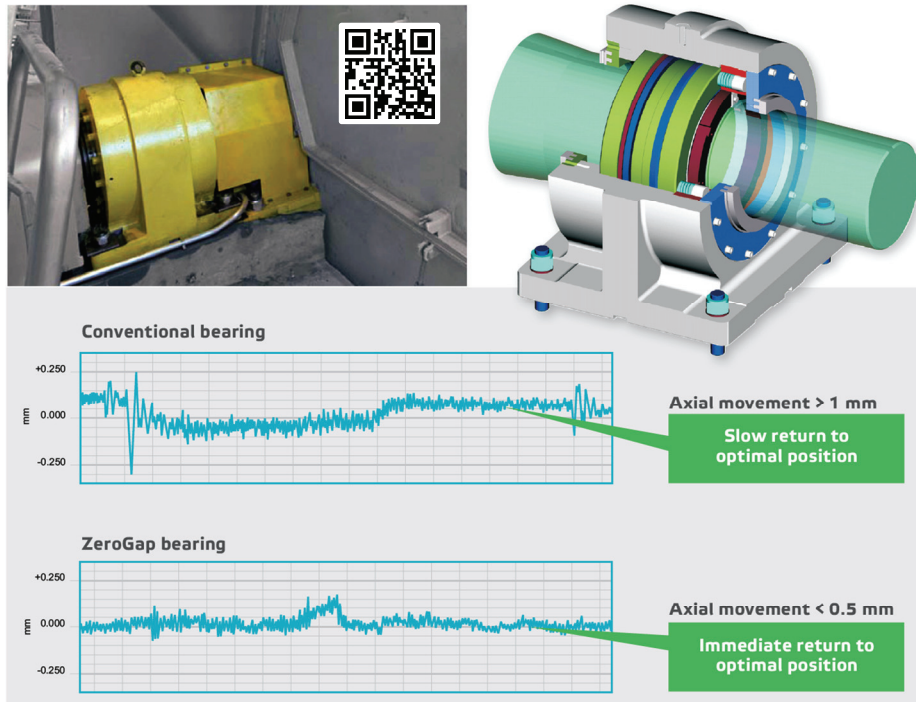

**Figure 20.** With the ZeroGap thrust bearing, axial movement is minimized.

In conventional drive systems the amount of power in the electric motor size has been determined by temporary chipping production peaks that are greater than during nominal production. The EasyDrive system equips the chipper with a flywheel and a frequency converter. The flywheel enables using less electricity to power the motor, which is now dimensioned according to the rated capacity. The rotational inertia of the flywheel is exploited during temporary production peaks.

Starting the chipper requires a huge amount of energy and results in a clear peak in power consumption. The frequency control drive enables a controlled start-up without overloading the electricity network.

The benefits of the EasyDrive system are:

- Less installed motor power in the chipper drive
- Enables control of rotating speed – cutting speed can be optimized for different wood qualities to give the best chip quality
- Reduces costs for electricity and the load on the electrical network

## Chip screening

A screening stage is often necessary to achieve the uniform chip size demanded in different processes. EasyScreen™ and CSR™ chip screen are designed for effective removal of oversize and fine fractions from the chip flow.

## EasyDrive chipping speed control system

The EasyDrive chipping speed control system (Figure 21) is designed to control the rotation speed of the chipper-knife disc. It also balances out power consumption peaks caused by load variations in chipping and decreases the installed electric power required for the chipper.

In conventional drive

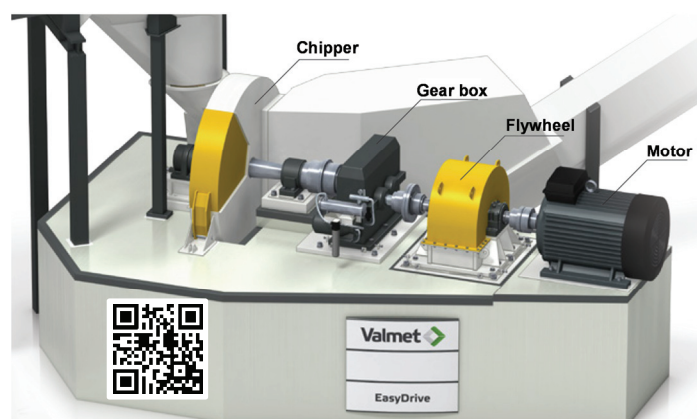

**Figure 21.** The addition of the flywheel and frequency converter in EasyDrive allows use of less electrical motor power, as the flywheel's inertia is used during production peaks.



## EasyScreen for effective chip screening

Excellent screening performance is guaranteed by the high rotation speed and large amplitude of EasyScreen. The effective spread-out chute feeds material evenly across the entire width of the screen deck allowing a thinner chip layer. The sizing of the screen deck provides an optimal screening area. EasyScreen is available in three sizes up to 1000 loose-m<sup>3</sup>/h. The infeed of the largest EasyScreen (**Figure 22**) is equipped with a separate vibrating chute to provide optimal chip distribution and to improve fines separation.

The flexible rubber bottom pan minimizes sticking of fines, pitch, snow and ice to the fines deck and ensures efficient fines removal in even the most severe weather conditions.

Chips are sorted using screens into different fractions based on their size. This is necessary to permit uniform pulping.

Screening should be trouble-free, effective and reliable.

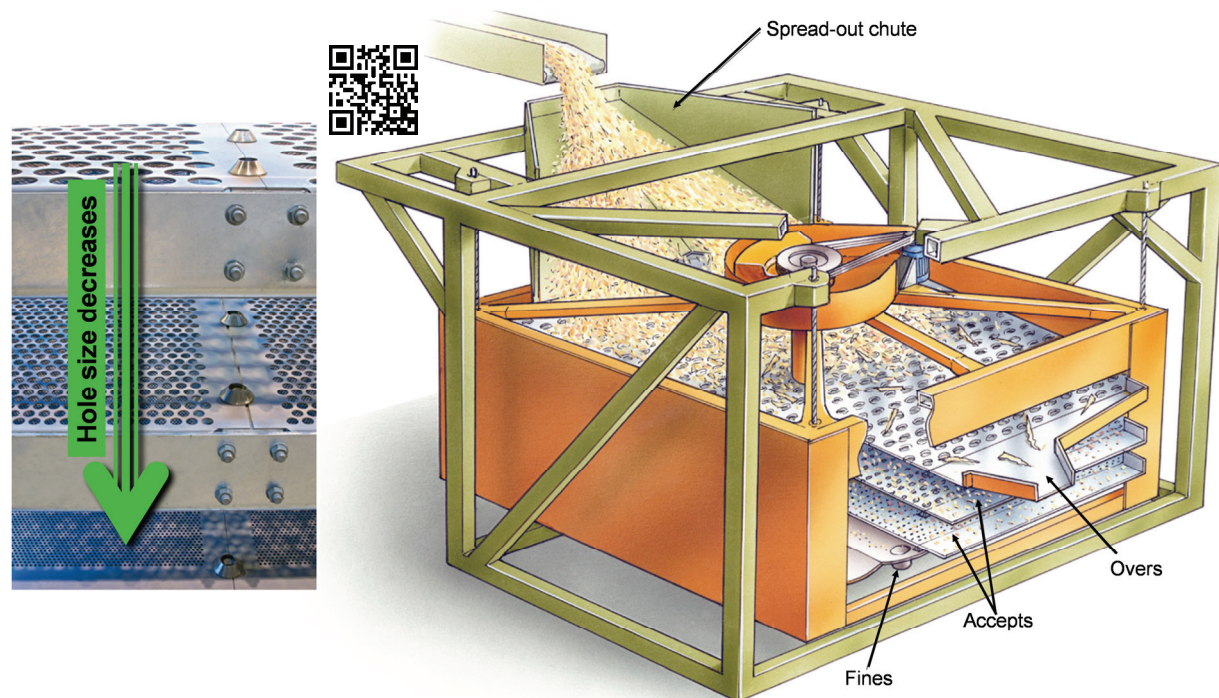

**Figure 22.** EasyScreen uses perforated screen plates for separation of different fractions.

EasyScreen has a non-welded construction, low stress levels and a friction joint principle. The spread-out chute is fixed on the screen support frame instead of the screen basket, thus increasing the rigidity and durability of the basket.

A screen basket made of hot galvanized steel and a bolted assembly enable high reliability. The surface treatment is practically maintenance-free. The drive unit is located above the screen basket to facilitate maintenance.

The screen basket is delivered as one complete unit, enabling fast and easy installation. The screen is supplied with an automatic lubrication unit for the bearings.



## CSR chip screen

The CSR screen provides savings in building costs thanks to an ingenious support design. This means a low screening room and flexible screening layout with several alternatives for overs discharge.

The optimal rotation speed gives the best possible screening result. The chips are fed evenly with the chip spread-out deck, utilizing the entire screening area.

The patented Live Bottom pan (Figure 23) prevents fines from sticking to the bottom even with high pitch content in the chips and ensures efficient fines removal in the severest of conditions. The closed fines discharge minimizes the amount of dust in the environment.

All screens are test run prior to delivery. The screens are delivered as one complete unit, enabling easy and fast installation. The screen is supplied with an automatic lubrication unit for the bearings. The CSR chip screen is available in five sizes up to 1000 loose-m<sup>3</sup>/h.

## Valmet NanoPlate™, a special coating to eliminate blocked screen plate holes

On traditional screen plates dust and wood resin attach to the uncoated screen plate and chute where there is no regular material flow. This slowly blocks the screen holes, which extends downtime for cleaning screen plates.

NanoPlate (Figure 24) from Valmet eliminates blocking by preventing dust and wood resin accumulation on screen plates. The coated screen plates keep the screen holes open and the plates remain clean. The coated plates also decrease downtime for screen plate cleaning.

## Chip handling and storage

Chip storage is necessary to ensure the optimal supply of chips to the process. The reclaimer is designed for automatic and reliable reclaiming of chips, bark or sawdust from an open pile or storage silo.

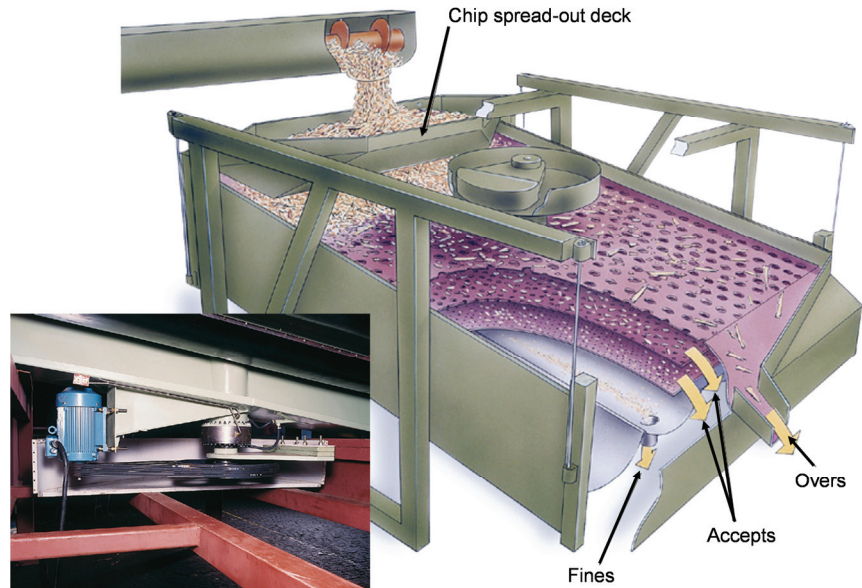

*Figure 23. The CSR chip screen's self-cleaning Live Bottom pan prevents fines from sticking to the screen bottom.*



*Figure 24. NanoPlate coating (left) compared with traditional screen plate with no coating (right) shows the cleaner surface achievable with NanoPlate.*

## GentleStore™

GentleStore provides the latest cutting-edge technology for wood-chip storage and reclaiming. This chip storage system (**Figure 25**) operates on the first-in first-out principle, meaning the chip pile is built up at the front and reclaimed from the back. The chips are reclaimed gently from the whole cross section of the pile, which ensures excellent blending and homogenization of the chips while minimizing chip damage.

GentleStore includes several unique features and allows low operation and maintenance costs, making it a beneficial total investment. The benefits include:

- Excellent chip blending
- Gentle reclaiming prevents chip damage
- First-in first-out operating principle
- High stacking and reclaiming capacity
- 100% automatic reclaiming
- Low operation and maintenance costs
- All equipment visible and easy to access
- Enables easy and flexible mill layout
- No concrete



**Figure 25.** The GentleStore chip storage system builds the chip pile from the front and reclaims from the back, across the entire cross section of the pile.

## RecAll reclaimer

With the RecAll reclaimer no bulldozers or front loaders are needed, which means minimal chip damage.

The first in-first out principle reclaims chips from the bottom of the chip pile, eliminating the deterioration of the chips during storage.

Reclaiming through the whole width of the pile (**Figure 26**) guarantees excellent blending and homogenization of the chips. An extremely wide reclaim opening enables high-volume storage with automatic reclaiming.

The RecAll screw reclaimer is supported on a track at both ends of the screw. Material is reclaimed by the rotating screw onto a conveyor. At the same time, the reclaimer

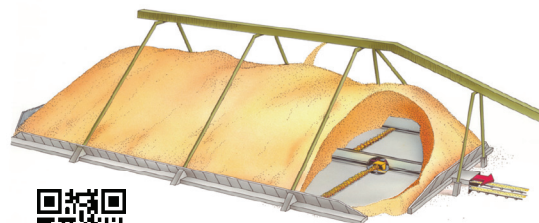

**Figure 26.** The RecAll chip storage system uses a screw supported on a track to reclaim chips on a first-in first-out basis through the entire width of the pile.

Typically, the largest production cost at a pulp or paper making plant is the raw fiber. Maintaining chip quality during storage is paramount to retaining product value.

Wood fiber deterioration from biological reactions, physical damage or contamination must be minimized.

First-in first-out storage and reclaiming using high availability storage systems is the most effective way to guarantee delivered chip quality.

moves slowly along its track. The reclaim rate can be adjusted by a frequency converter (optional feature). One or more RecAll reclaimers can be installed on the same track.

### Traversing screw reclaimer

The traversing screw reclaimer features high reliability thanks to the extremely strong and simple construction. Long lifetime is ensured by the heavy-duty reclaimer design combined with low rotation speed. The large reclaiming area minimizes the need for front loaders in open piles. 100% automated reclaiming is achieved from silo storage. The traversing screw reclaimer allows easy accessibility to drive units and other service points.

The cantilever screw reclaimer is supported on two tracks, one installed on the service tunnel ceiling and the other on the floor. Material is reclaimed onto the conveyor below by the rotating screw. At the same time the reclaimer moves slowly along its track. The reclaim rate can be adjusted by a frequency converter (optional feature). One or more screw reclaimers can be installed on the same track

### RotaRecAll reclaimer

RotaRecAll's automatic reclaiming prevents chip pile deterioration. Since no bulldozers or front loaders are needed, chip damage is minimal. RotaRecAll reclaims through the whole cross-section of the chip silo (Figure 27). This, combined with the first-in first-out principle, guarantees excellent homogenization of the chips for further processing.

With the RotaRecAll reclaimer, it is possible to build large silos for 15,000 – 26,000 m<sup>3</sup> chips. Silo storage eliminates wind screening and keeps chips clean. It also prevents the release of dust and noise into the environment.

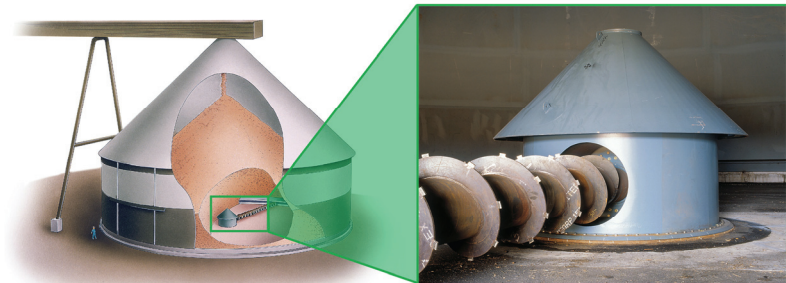

**Figure 27. The RotaRecAll reclaimer reclaims through the entire cross-section of the chip silo as the screw slews under the pile feeding the chips to the middle and down onto a conveyor beneath.**

The RotaRecAll screw reclaimer is supported at both the center and periphery of the silo. The screw slews slowly under the pile, feeding material through a hopper onto the conveyor beneath. The reclaim rate can be adjusted by a frequency converter (optional feature).

### Rotary screw reclaimer

This machinery features high reliability thanks to the extremely strong and simple construction. A long lifetime is ensured by the heavy-duty reclaimer design combined with low rotation speed. The large reclaiming opening minimizes the need for front loaders in open piles. 100% automated reclaiming is achieved from silo storage. Easy accessibility to drive units and other service points is provided.

The cantilever screw reclaimer rotates under the chip pile, and feeds chips through a hopper to the conveyor beneath. The reclaim rate may be optionally adjusted by a frequency converter.



## Bark and biomass handling and storage

The bark from the debarking process can be transformed into useful energy in a mill's power plant. The energy value is dependent on the dry content of the bark. Valmet has supplied several hundred bark presses, systems and equipment for handling and storage of bark worldwide, including the following components: WoodSaver™ wood recovery systems, bark shredders, bark crushers, disc scalpers, MagicChute™ bark presses, belt dryer, receiving pockets, bark silos, bark stockpiling and stackers and reclaiming systems.

### WoodSaver

WoodSaver (**Figure 28**) is a special roll conveyor system designed to maximize wood-usage efficiency in debarking lines. The system saves wood by separating usable wood pieces from the bark line and returning the recovered wood back to the process, instead of burning them as waste together with the bark. WoodSaver can also be installed in existing lines to increase the wood-raw material yield of the mill.

The construction of WoodSaver is simple and functional. The recovery system consists of a separating roll conveyor, a chute for bark and debris, and an adjustable inclined conveyor for stone removal. Stone removal enables the mill to minimize the damage and wear of the bark crusher and its knives.

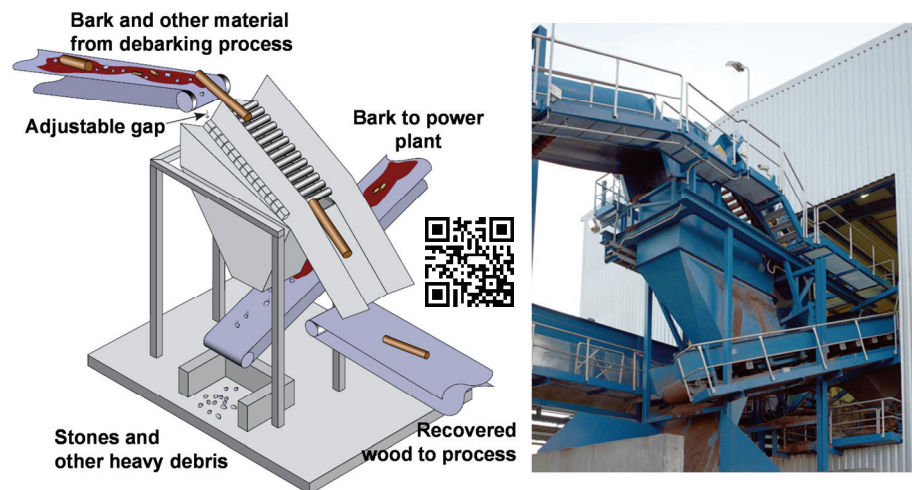

**Figure 28.** WoodSaver separates wood and stones from bark, minimizing damage to the bark crusher and increasing wood yield.

Reclaimed bark and biomass can produce energy at a mill power plant.

First-in first-out stock rotation reduces the risk of self-heating and drying improves energy production.

Additional requirements are operational reliability, adequate fire prevention, minimized dust generation and removal of contaminants.

### Bark Shredder

The Bark Shredder is designed to reduce bark into optimally sized particles, ready for various applications. The shredder successfully combines high capacity, excellent shredding performance and space-saving design.

The design incorporates simple robust construction, a one-piece fabricated frame, vertical rotor, large in-feed opening and centrifugal discharge. The rotor knives are pivoted to avoid damage by foreign particles such as small stones and metal pieces occasionally found in the bark. The variable rotation direction means that all the knife edges can be used. This results in fewer knife changes.



All parts are easily accessible. The rotor knife change can be performed through the wide maintenance door. The compact design of the shredder enables easy mounting to its foundation by bolts. As an optional feature the shredder can be equipped with separate mounting rails for easy maintenance and mounting. The Bark Shredder (**Figure 29**) is available in two sizes depending on capacity.

### Bark Crusher

The Bark Crusher (**Figure 30**) is designed to reduce bark into optimally sized particles, ready for further processing. The crusher combines high capacity with excellent crushing performance.

Bark is fed through a feed chute into the crusher. The horizontal rotor is equipped with pivoted hammers attached to the shafts. While rotating, the hammers crush the bark through the bottom grate. The fraction size of the crushed bark can be changed by adjusting the size of the hole of the bottom grate.

The crusher hammers and the bottom grate are made of wear-resistant steel. The hammers with hard-welded wearing parts can be turned, which ensures extended lifetime. A stone trap and shear pin coupling protect the rotor against foreign material. The frame is made of steel plate and furnished with replaceable heavy-duty wear plates. All parts are easily accessible, thanks to the large maintenance openings. The drive consists of an electric motor and a flexible coupling.

### Belt dryer

The belt dryer (**Figure 31**) is designed to remove water efficiently by evaporating moisture from wet biomass. Its proven drying technology ensures the high dryness of the end material. The belt dryer is suitable for drying biomass like bark, wood chips, sawdust, bagasse, etc. After drying, this waste material is ready to be used as biomass fuel.



**Figure 29.** The Bark Shredder is a high capacity method of converting bark to usable sizes for further processing.

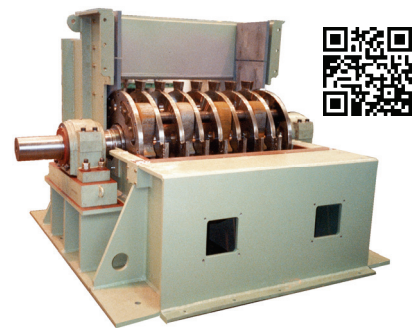

**Figure 30.** The Bark Crusher (shown with half of cover removed) reduces the size of bark using rotating hammers.

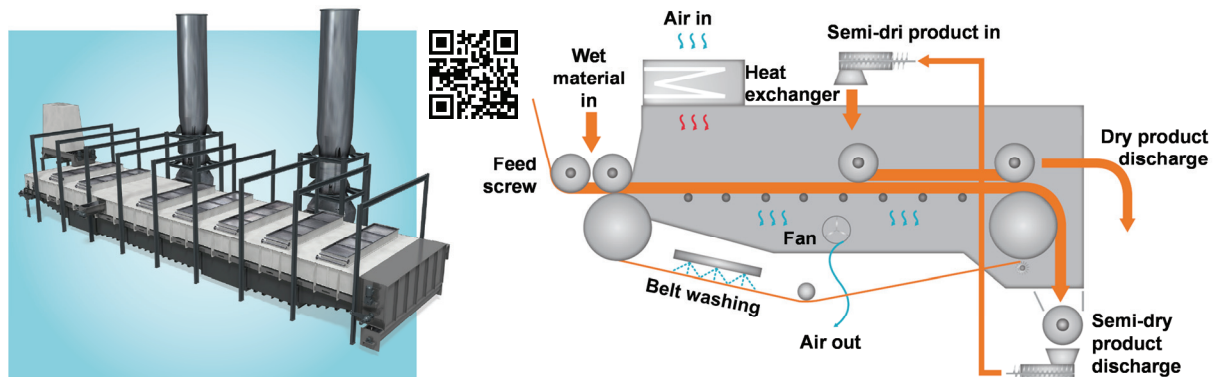

**Figure 31.** The belt dryer is used to dry biomass such as bark, wood chips, sawdust, bagasse, etc. before further use such as gasification, pelletizing, power boilers and wood powder firing.

The belt dryer features evaporation of between 2 to 25 tonnes of water per hour and allows continuous dehydration of up to 8% residual moisture. Several sources of energy such as waste heat (water), low-pressure steam or hot air can be used - no primary energy is needed. An even distribution of material and controlled air flow guarantee uniform residual moisture in the material.

The wet material is distributed by a special feed system onto a belt in an even layer. The heated drying gas flows through the material layer and the drying belt. The hot drying gas is cooled and saturated by absorbing water from the material. The now moist drying gas is vented at the stack(s) via one or several fans, depending on the plant size. At the belt end, the material layer is discharged from the dryer.

With the speed adjustment of the exhaust fan according to the energy available, the dryer is always run with the least possible power consumption and at a low temperature. For bigger drying capacities several dryers are needed which can be installed one on top of the other to save floor space.

## Process control systems

During the past 15 years, process control systems in wood handling have gone through a revolutionary change from mechanical operation to automatic control with a large variety of equipment using optical and laser technology previously unknown in the woodyard. Valmet's extended scope of supply for special measurement in wood handling encompasses devices with the following trade names:

**GentleMatic** (Figure 32) and **EasyMatic™** are smart process optimization systems for debarking which operate independently above the actual control automation and can be connected to any DCS/PLC system. The benefits of optimization are raw material savings, reduced energy consumption and interruption-free process functions. The smooth and stable operation also reduces maintenance costs.

**ProfiSmart™** measures wood content in the bark (wood loss) and **BarkSmart™** cleanliness of debarking on the wood surface. These systems feature on-line camera measurements for the wood content of bark and bark content of logs on the debarking line as well as transmission of the collected and analyzed data to debarking control.

**VisiChips™** is an optical chip quality analyzer designed for the simultaneous measurement of chip size distribution, length, width and thickness. Additionally, it can be extended to measure chip quality factors, such as chip surface brightness, the extent of bark and other impurities in chip flow, changes in chip surface moisture, and material volume flow on the conveyor.



*Figure 32. GentleMatic optimization measures critical process parameters and calculates the best operating conditions for target capacity and desired wood cleanliness.*

Monitoring and controlling the wood handling process is critical for maintaining high levels of safety, production and strict product quality.

Automated controls and measurement systems provide non-stop process control to the desired production parameters.

**FillSmart™** features optical measurement of the filling degree of a debarking drum, giving precise information regardless of changes in wood quality. The data provided facilitates the optimization of debarking and furthermore the stable functioning of the whole line.

**VisiLoad™** analyzes the filling degree of a feeding conveyor based on laser technology that provides information on the length, height and weight of the pile. Measurement results and calculated values are further utilized in debarking control management.

**VisiQ™** uses a high-accuracy laser scanner for optical measurement of the cross-section of the logs or chips on the conveyor. The volume flow of the logs can be calculated based on the conveyor speed, and the device also provides information on log diameters and log lengths.

**SoundTrap (Figure 33)** is used for detecting unknown particles in the material flow, such as stones, metal and lumps of ice. A detector signal alerts process control to eliminate the particles for safe operation of the line.

**QS™** is an intelligent measuring device, designed for on-line wood sample quantity and quality measurement. Using laser technology and cameras it represents the latest innovations in the field. It has proven its reliability in recent installations. Compared to earlier measuring methods, the QS device, mounted directly above the line, saves space, cost and time, and is one of the most successful concepts in wood handling process optimization.

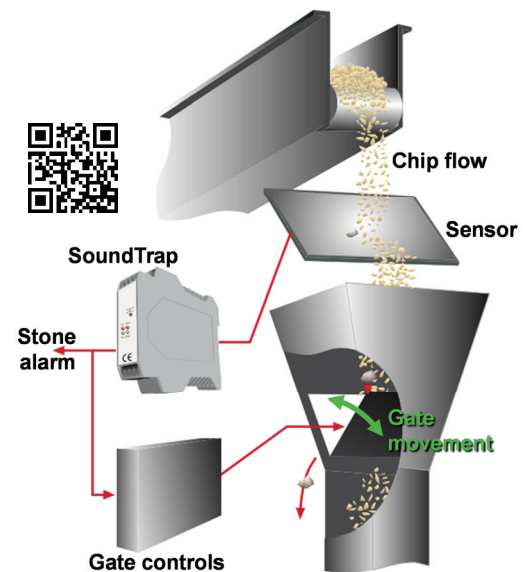

**Figure 33.** SoundTrap detects unknown particles in the material flow such as stones, metal and ice, and signals a diverter gate.

## Case Study – Fibria Três Lagoas

The Fibria mill, located in Três Lagoas, Mato Grosso do Sul in Brazil, was started up on March 30, 2009, and at the time was the largest single fiberline mill in the world. The mill had an annual capacity of 1.3 million tons of bleached eucalyptus pulp. All of the fiber for the pulp and paper products comes from the company's own eucalyptus plantations within an average radius of 60 kilometers from the mill.

For the brand new mega size pulp mill (**Figure 34**), Valmet was awarded the contract to supply one of the wood handling lines, the black liquor evaporation system, and the recovery and power boilers. As the pulp line approached its first anniversary, the workers of Três Lagoas celebrated not only the advance in production speed, but also the fact that the equipment delivered by Valmet brought the results projected and, in some cases, even more. Even with the audacious building schedule of 19 months, the project was concluded one month in advance. "It was a record, because there was a lot of technology applied," the project manager says.



- Pulp wood receiving: 375 m<sup>3</sup>/h
- Log infeed: GentleFeed system, length 18 m
- Equalizing drum: 17 m long, 4.5 m diameter
- Conveyor systems
- Camura GS chipper: 15 knives, 3.35 m disc diameter,

**Figure 34.** Valmet supplied one of the wood handling lines for the new Fibria Três Lagoas pulp mill.

The project aimed to combine energy saving with the best resource usage. The mill is self-sufficient in energy, with wood biomass as its primary energy source. The recovery and power boilers were also installed using an island concept, in which both share the same building and many auxiliary systems.

Valmet provided one of the three chipping lines that receive debarked logs from the forest. The facility was sized to receive and process 375 m<sup>3</sup>/h of wood, which at that time was the biggest eucalyptus chipping capacity available in a single line. The woodyard project was implemented smoothly, because the equipment was supplied pre-assembled, which greatly facilitated the work.

Valmet technology was chosen for the project due to its high chipping capacity, an essential factor for the mill to achieve full capacity. The line is loaded with 6 meter logs through a GentleFeed conveyor that operates with bars activated by hydraulic cylinders. The logs then enter a 17 meter long equalizer drum whose function is to regulate the log flow to the chipper. The equalizer drum runs on rubber tires, with each of the 12 drive units comprising four tires, which simultaneously support and drive the drum. Before entering the chipper, the logs pass over a GentleBarking roll conveyor and a metal detector, which separate bark, small pieces of wood and metals from the wood flow. The Camura GS 1050 chipper, with gravity feeding and a 3.3 meter disc, is the largest in operation in Brazil. Fibria confirmed that, after a year's operating experience, the wood chipping efficiency of Valmet's line was even higher than originally projected.

The Fibria Três Lagoas goals were to save energy and use raw materials efficiently while operating at high capacity.

The GentleFeed drum infeed conveyor, GentleBarking roll conveyor and Camura GS chipper protect the raw material while efficiently separating bark and creating high quality chips.

The mill is operating at high capacity and efficiency is even higher than expected.

## Summary

Wood, one of nature's renewable and valuable raw materials, is an indispensable source of pulp, paper and panelboard. At each mill, wood handling is the very start of the processing chain. Since the wood raw material varies greatly depending on the location of your mill, the main challenge is how to handle these various species of wood in the right way. That means treating the raw material as gently as possible to make it perfect for further processing and to get the best possible yield.

Valmet wood handling technology and process experience turn your valuable wood raw material into high-quality chips, giving the best possible start for the next stage of your processing chain. Trust Valmet for gentle, high capacity, profitable woodyard operations.

*This white paper combines technical information obtained from Valmet personnel and published Valmet articles and papers.*

*Valmet provides competitive technologies and services to the pulp, energy and paper industries. Valmet's pulp, paper and power professionals specialize in processes, machinery, equipment, services, paper machine clothing and filter fabrics. Our offering and experience cover the entire process life cycle including new production lines, rebuilds and services.*

*We are committed to moving our customers' performance forward.*