

Valmet

Technical Paper Series

Steam & Condensate System Improvements

Executive Summary

Steam & Condensate (S&C) Systems distribute steam, regulate steam supply, control condensate removal, and ensure efficient re-use of flash steam and blowthrough steam in the dryer section. This includes equipment such as thermocompressors, control valves, syphons and joints, separators, pumps, automatic blowthrough control systems, etc., as well as detailed piping design.

The S&C system works with the dryer section hood and ventilation equipment, runnability and heat recovery systems to provide the papermaker with all the equipment necessary to ensure full control over drying performance and energy consumption of the dryer section.

This paper describes the function and components of the S&C system, and presents Valmet options for key components and services to improve S&C efficiency and runnability. Case studies that illustrate a total system approach and the DryingMaster control system are included.

Valmet Air Systems

Valmet's Air Systems business in North America traces its roots back to 1961, when John Armstrong, an entrepreneurial engineer from Thunder Bay, Ontario, Canada, formed a fledgling company to provide paper machine ventilation and heat recovery equipment. During the next two decades, the core organization of J. A. Armstrong and Associates Ltd. continued on through a few changes in ownership. Its descendent, Enerdry Corporation, was acquired by Valmet in 1987. Valmet changed its name to Metso Paper in 2001. In 2014 Metso's pulp, paper and power group changed their name to Valmet.

Many of the technological innovations first developed by the North American engineers have contributed to Valmet's current air systems product line. The leadership in new product development that started in those early days is still just as vital today. Valmet practices a total system approach combining all air systems disciplines into one comprehensive group.

The need for steam and condensate system improvements

In the 1960s, the company provided paper machine hoods, ventilation and heat recovery equipment. Pocket ventilation (PV) was tested in a Thunder Bay paper mill in 1967, which when combined with new open-mesh dryer fabrics in the 1970s, flooded the dryer pockets

with low-pressure air, thereby lowering and leveling the humidity across the machine. These systems provided tremendous paybacks by increasing production rates and allowing higher sheet moisture levels. However, PV systems also increased the condensing rates in the dryer cans, requiring redesign of steam and condensate systems to avoid flooding and control problems. The expertise in two-phase (steam and condensate) flow developed over thirty years has resulted in Valmet air systems that stabilize dryer operation with blowthrough flow control. More recently, energy efficient design and operation has become a focus of research.

Today, increasing speeds and the need for higher and higher drying capacity and improved quality continue to create more demanding requirements. This has led Valmet to research and develop more solutions for steam and condensate systems and their corresponding state-of-the-art controls. Air Systems engineers from Valmet operations in Turku (Finland), Gorizia (Italy) and North America continue to pool their expertise to develop and refine new products.

Steam and condensate systems

All pulp, paper, board and the majority of tissue machines have steam and condensate systems. The objective of the steam and condensate system in the paper machine is to provide the steam for the drying. In the dryer section the moisture is evaporated as the sheet is pressed between a fabric and the hot drying cylinder.

Figure 2 (next page) is a Valmet dryer cylinder without gear unit, showing key steam and condensate features such as a steam and condensate joint, a condensate joint, condensate flow indicator, dryer bars, syphon (which will be covered in detail later in this paper) and their relationship to the dryer cylinder and its bearings, head and shell.

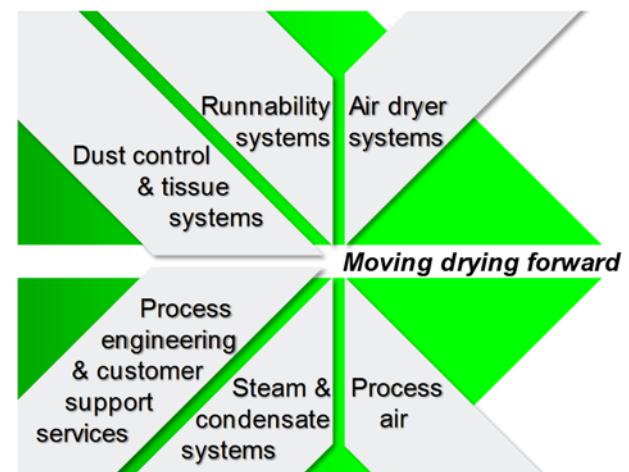

Figure 1. Valmet Air Systems uses a total system approach to drying.

Purpose of the steam and condensate system

The purpose of a paper machine steam and condensate system is to provide the temperature for drying using steam pressure and to remove condensate while providing sufficient drying energy and achieving sufficient dryer surface temperatures. However, this must be performed efficiently and precisely, following these guidelines:

- Control steam pressures for optimum drying, maximum drying capacity, good runnability and excellent sheet quality (CD and MD moisture profiles). This includes managing pressure in dryer groups, pressure difference between steam groups and minimizing the steam sent to the residual heat exchanger.
- Provide stable control over entire operating range, including warm-up, grade changes and sheet breaks.
- Efficiently remove condensate from inside the dryers for maximum drying capacity and uniform cross direction dryer surface temperature profiles.
- Remove air and non-condensables for rapid warm-up and uniform cross direction dryer surface temperature profiles.
- Minimize steam use by returning all condensate and by efficient reuse of blowthrough and flash steam.
- Be easy to use and require minimum operator interaction.

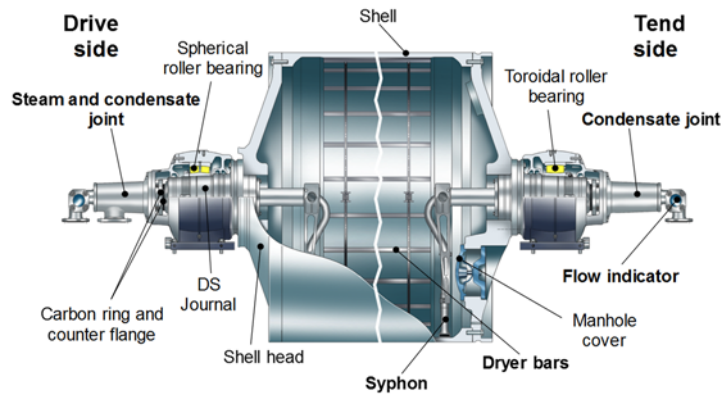

Figure 2. Valmet dryer cylinder showing steam and condensate elements

Definitions

There are a number of examples of "technical terminology" used when describing steam and condensate systems that should be explained for ease of understanding:

Latent Heat: The heat required to change water to steam at boiling temperature. This heat is given up when steam is condensed.

Non-Condensables: Those gases which are present to a small degree in all steam, which do not condense to a liquid like steam. They usually consist of air/ i.e., oxygen, nitrogen and carbon dioxide. An accumulation of these gases will tend to lower the steam temperature and affect drying.

Saturated Steam: Steam existing as 100 percent vapor that is at a temperature where any further heat removal will cause a portion of the vapor to condense to water. 'Wet steam' at the temperature of the boiling point which corresponds to its pressure.

Superheated Steam: Steam existing as 100 percent vapor which is at a temperature greater than the temperature of saturated steam, i.e. steam heated to a temperature higher than the boiling point corresponding to its pressure. Dry steam which cannot exist in contact with water, nor contain water, and resembles a perfect gas.

Blowthrough Steam: Steam that is not condensed in the dryer and which blows through the syphon shoe and passes out of the dryers with the condensate.

Separator: A tank into which the blowthrough steam and condensate from the dryers collect. The condensate settles to the bottom and the steam leaves through the top connections and is used for other steam sections or heating air or liquids.

Syphon: A pipe inside the dryer through which condensate is removed from the dryer. The pipe extends down close to the dryer shell to keep the condensate film as thin as possible.

Condensate: The water that is formed when steam cools and condenses.

- Atmospheric moisture that has condensed because of a temperature drop.
- Condensed steam, re-circulated back to the boiler again.

Differential Pressure: The difference in pressure between two (2) points, for example, the difference in pressure between the steam header (manifold) and condensate header (manifold) in a dryer section.

Flashing: The process of condensate changing to steam when pressure on the condensate is reduced. The energy (enthalpy) made available when pressure is reduced will evaporate part of the water producing flash steam.

Water evaporation

The final drying is achieved in the drying section. This is achieved by means of several steam heated dryers (cylinders or 'cans'). These are driven in groups of multiple cylinders together. The paper sheet runs over a large number of dryers.

The temperature of each of the dryer surfaces must be exactly controlled. In the first group this might be 70 °C (160 °F) and then rise slowly to 185 °C (365 °F) in the later groups at the dry end depending on the paper produced.

The dryer section of the paper machine must evaporate the water from the sheet not removed by the former and presses. The sheet enters the dryer section at approximately 50-60% water by weight. It is important that this percentage of water be kept as low as possible because an increase of 1% sheet entering moisture reduces the tonnage of paper dried by approximately 5%. The sheet leaves the dryer section at approximately 5% water by weight.

The dryer section evaporates a certain amount of water per ton of paper. The water vapor goes into the air being pulled from around the machine and the basement area into the dryer hood, and is exhausted to the atmosphere by the hood fans.

Condensate behavior and heat transfer

Steam is used as the heating medium in a dryer and enters the dryer in a saturated or near saturated state. As heat is conducted through the dryer shell and into the sheet, the steam is condensed to liquid, giving up its latent heat. The latent heat is the motive heat source for drying paper.

Figure 3 illustrates the four (4) main stages of condensate behavior as the dryer rotation speed changes:

- Stage 1 - **No rotation.** Condensate forms a pool in the bottom of the dryer cylinder.
- Stage 2 - **Puddling.** As the dryer begins to turn, the puddle moves

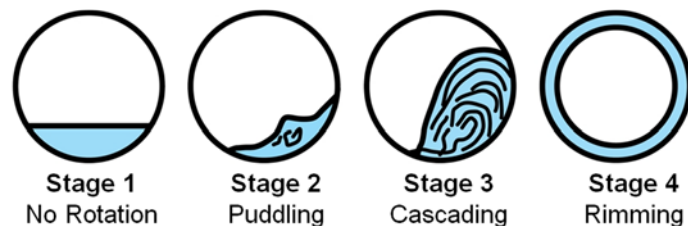

Figure 3. Condensate behavior as dryer rotational speed increases (left to right).

- up with the rotating dryer shell, and a thin film of condensate forms around the shell surface.
- Stage 3 - **Cascading**. Faster rotation of the dryer causes the puddle to move farther up the shell until gravity forces overcome centrifugal forces and the condensate showers back into the bottom of the dryer.
- Stage 4 - **Rimming**. As the dryer rotation speed is increased further, centrifugal forces overcome gravity forces so that the film thickness is uniform all around the dryer shell.

The cascading stage offers the best heat transfer because of the very turbulent conditions inside the dryer, but the power surges may cause gear and bearing problems. On high-speed machines, dryer bars are normally used to break up the rimming laminar condensate layer and thus improve heat transfer.

For a given diameter dryer, the speeds at which the above stages occur depend on the amount of condensate in the dryer. As the quantity of condensate in a dryer decreases, rimming will take place at a slower speed. This is important because the heat transfer process changes between the rimming and cascading stages. Most modern machines operate at speeds well above rimming.

Examining the drying process

Water exists in wood fiber as free water between fibers and in the fiber lumen. Water also exists as bound water within the fiber cell walls:

- Freezing water in pores in the fiber wall
- Nonfreezing water chemically bound in hydrophilic groups of fibers

The fiber saturation point is reached when all free water is removed. The fiber drying process is dependent on temperature and the relative humidity of the surrounding air.

In the papermaking process water is removed from the web in three ways as seen in **Figure 4**. Free water is removed in the forming, pressing and drying processes. Freezing water is removed in the pressing and drying processes. Nonfreezing water is removed in the drying process.

Drying in the multi-cylinder process

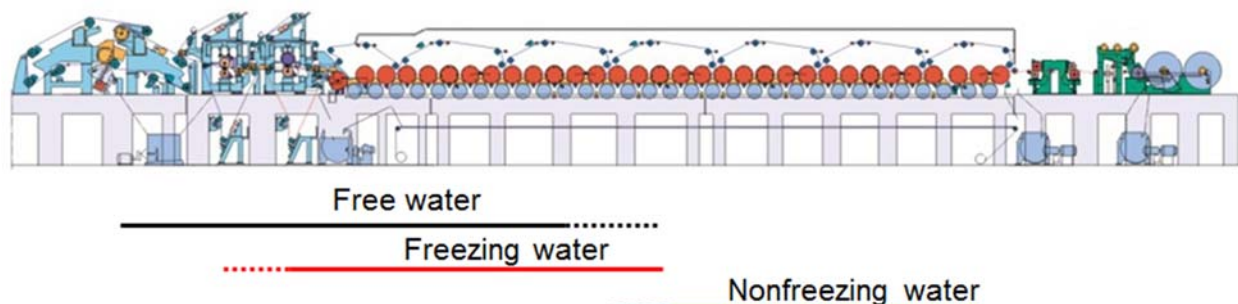

Figure 4. Water removal during the papermaking process

Steam heats the paper through the dryer shell to evaporate water from the web. The purpose is to maximize the heat transfer and drying rate. In order to accomplish this:

- The condensate layer must be optimized.
- The contact area between paper and cylinder surface must be maximized.
- The dryer shell must be clean.
- The steam temperature is 15-25 °C overheated.

Moist air is transferred out of the hood. The pockets are ventilated and dry hot air is brought into the hood.

Heat transfer from steam to paper

As steam condenses, latent energy is released. There is thermal resistance at different stages when heat is transferred to paper. This can be seen in **Figure 5** where a simplified version of Fourier's heat transfer rate equation is also shown. In the equation:

- Q = Heat transfer rate (rate of flow of heat inside cylinder to outside of paper)
- k = Heat transfer coefficient
- A = Contact area (of paper with cylinder)
- T_s = Steam temperature (inside dryer)
- T_p = Paper temperature (measured at outside of paper)

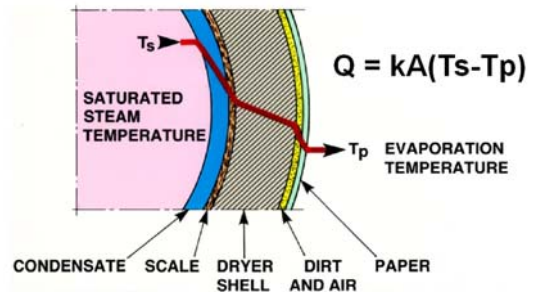

Figure 5. Heat transfer from steam to paper

The temperature (**Figure 5**, red line) drops as heat is conducted through different layers from the inside of the dryer to the outside of the paper:

- Condensate ring in the cylinder
- Scale and rust in the inner surface of the cylinder shell
- Cast iron cylinder shell
- Dirt and air gap (if any) on the outer surface of the cylinder
- The paper itself

As mentioned earlier, the addition of dryer bars in a dryer cylinder breaks up the condensate ring inside the cylinder, thus increasing the heat transfer rate for the same given steam temperature (T_s) and dryer pressure.

All of these layers offer some resistance to heat flow; some more severely than others. The cast iron dryer shell has a relatively low resistance to heat flow; however, the condensate layer has a high resistance to heat flow. For comparison, a 1" thickness of water (condensate) has approximately 70 times the resistance to heat flow as a 1" thickness of cast iron. Therefore, it is very important that the condensate layer be kept thin so that heat flow will always be at a maximum to dry as much paper as possible.

Condensate removal

Condensate is removed from inside a rotating dryer with a syphon, as shown in **Figure 6**. The two main types of syphons are:

- Stationary (Cantilevered through the journal from outside the dryer cylinder, does not rotate with the dryer), and
- Rotary (fixed to the dryer shell, rotates with the dryer).

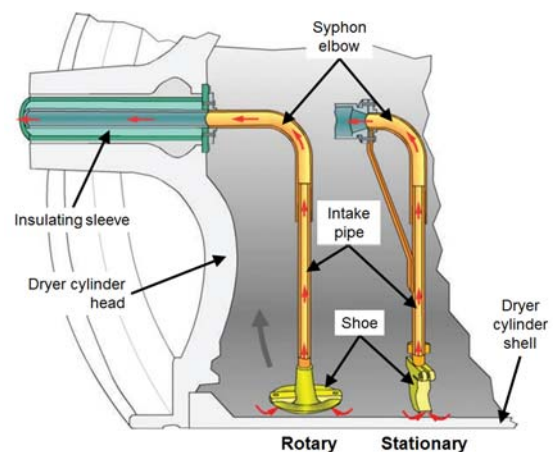

Figure 6. A rotary (left) or stationary (right) syphon removes condensate from the inside surface of the dryer cylinder shell.

All modern syphons require a certain amount of differential pressure and blowthrough steam to properly evacuate condensate and non-condensable gases (air). Blowthrough steam is defined as steam that is "blown through" the dryer, without condensing and thus not giving out its latent heat. For a given set of conditions, there is always a certain relationship between the differential pressure and the amount of blowthrough steam.

The condensate rate must be in balance with the amount of the "blowthrough" steam flow. The "blowthrough" steam is normally reused in the cylinders of lower temperature.

The differential pressure vs. blowthrough steam characteristics determine the design of the steam and condensate system and are very dependent on the type of syphon that is used. Therefore, it is very important that the condensate layer be kept thin so that heat flow will always be at a maximum to dry as much paper as possible.

Steam and condensate system design and maintenance

The steam and condensate system design is based on the paper sheet weight and the machine configuration by the machine manufacturer. The main components are shown in **Figure 7**.

Cascade system

At this point it is best to describe the cascade system as a whole, before reviewing the different components. **Figure 8** illustrates the principle of a cascade system and the flows of steam, condensate and water.

Fresh, slightly superheated steam is supplied to the dryer groups. Steam pressure is controlled in each group. Steam then partially condenses inside the cylinders. The released energy is transferred through the cylinder shell into the paper. The blowthrough steam and condensate are removed from the dryer cylinders into condensate tanks. Blowthrough and flash steam is fed to lower pressure groups. Condensate is collected into the main condensate tank and pumped back to the boiler.

The pressure difference between the steam and the condensate side is controlled in two steps. Coarse control is done with orifice plates placed in every condensate pipe. After the orifice plates the condensate side pressure is 20 kPa lower than on the steam side. Fine control is done with differential pressure control valves at the condensate tanks.

The orifice plates are dimensioned to reduce pressure 20 kPa. They restrict blowthrough steam to 10-15% of supply volume while allowing free condensate flow.

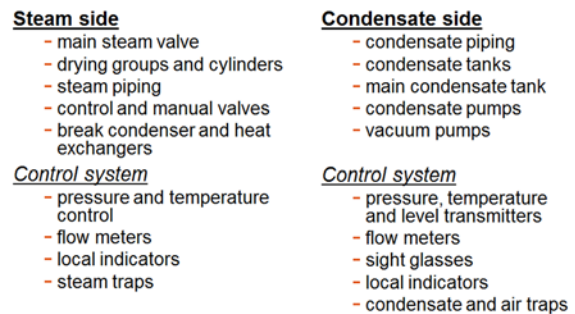

Figure 7. Main components of a steam and condensate system

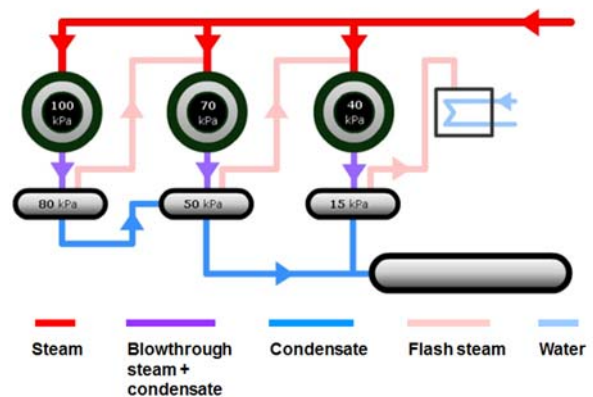

Figure 8. The principle of a cascade system: higher pressure steam is reused in lower pressure groups.

Steam pressure must be carefully controlled during sheet breaks. **Figure 9** demonstrates how the steam setpoint and actual pressure value are controlled during a sheet break.

Thermocompressor circuit

The thermocompressor circuit (**Figure 10**) recirculates blowthrough steam in a group of dryers. Under normal operating conditions all blowthrough is recirculated, except a small bleed to prevent accumulation of non-condensables.

During warm-up, the thermocompressor is shut off in order to purge air from the system.

Condensate removal is controlled with automatic blowthrough control (ABC) or blowthrough steam velocity control rather than conventional differential pressure control. The steam groups can be controlled independently of each other. The risk of flooding dryers is eliminated. The controls are simple, and once set; there is little need for operator intervention. ABC also works on cascade systems.

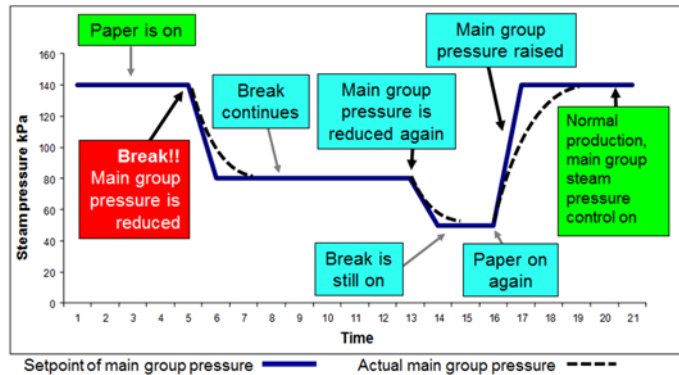

Figure 9. Steam pressure control during a paper break

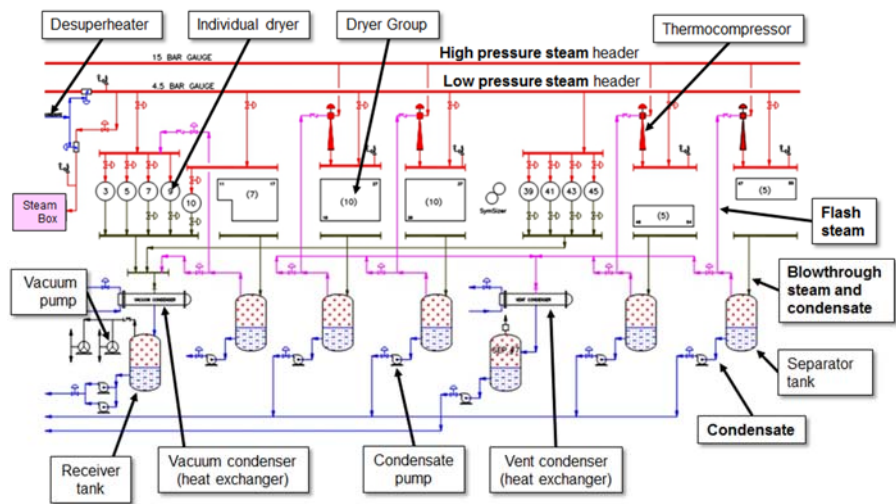

Figure 10. Flow diagram for a thermocompressor steam and condensate system

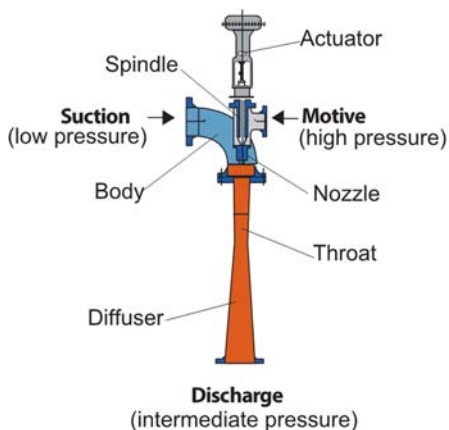

Figure 11. The thermocompressor circuit recirculates blowthrough steam in a group of dryers.

The condensing load drops significantly when there is no sheet, therefore a vent condenser is needed to maintain drainage at dryers without the sheet (needed especially with rotary syphons). In **Figure 10**, the last two dryer groups (right) are top and bottom – for curl control.

The thermocompressor (**Figure 11**) recompresses / repressurizes steam. It makes a dryer group completely independent of any other group, as opposed to a cascade system which goes successively from higher to lower pressure systems. (Note: Yankee dryers are all thermocompressors because there is no place to take the steam after the Yankee, i.e. no lower pressure dryers to use the steam in a cascade fashion.)

Steambox

A well-functioning steam box is necessary for higher dry content of the paper after the press, reduced steam consumption and better runnability. The steambox heats the web by injecting steam into the sheet (Figure 12). When the sheet then goes into the nip dry content is improved (i.e. the pressing effect) due to the water's viscosity decrease. This makes it easier for water to leave the sheet, therefore the sheet becomes dryer after exiting the nip.

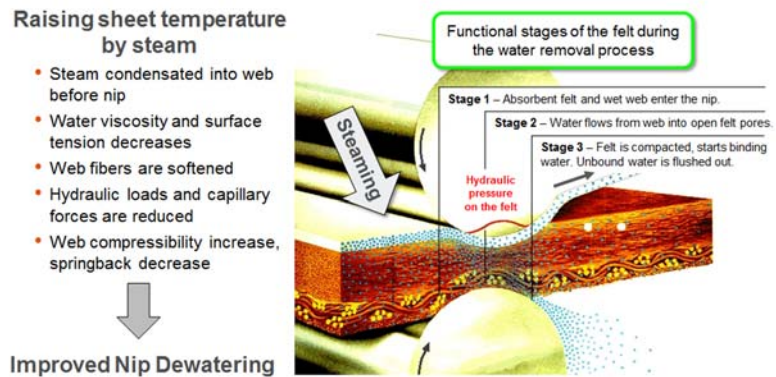

Figure 12. Principle of steambox operation (Valmet IQ Steam Profiler)

Profiles are improved due to steam flow control in 3-inch zones, which allows operation at a higher reel moisture. An improvement of 1-2% moisture at the reel enables the papermaker to sell more water in the sheet - rather than fiber, for example. The web temperature going into the dryers is increased which allows the operator to increase the steam pressure/temperature in the dryers without fiber picking.

If the profile is good enough, i.e. flat (obtained with a good control system), the 2-sigma is lower and uniformity is higher. In this case customers will tend to accept 0.5-1.0% higher moisture in the final product coming from the paper mill.

In general, increasing sheet temperature 10-14 °C in the press section will improve sheet dryness by 1%, leading to increased production or comparable decrease steam consumption in dryer section 3-4% (TAPPI TIS 0404-22). An increase of one percentage unit in web dry content after the press reduces steam consumption in the dryer section by 4%, which decreases the heat energy used for making one ton of paper by approx. 80 to 176 MJ. For example, a 3% higher web dry content after the press enables an increase of up to 200 m/min in paper machine production speed. These benefits can only be achieved if the steam box operates correctly and without problems. Valmet provides steambox process and condition testing services for all makes of steamboxes.

Steam and condensate system components

Syphons and joints

As shown in Figures 6 and 13, the drying cylinder incorporates certain drainage elements: joints and syphons. The siphon can be stationary or rotating.

The steam pressures and pressure differentials change as the paper travels through dryer section. Typical approximate pressures and differentials in each dryer group for a machine running at 1200 m/min (4000 fpm) are shown in Table 1 (next page).

Stationary vs. rotary syphon

A steamfit/syphon may operate with either a stationary or rotary syphon (Figure 14, next page). The stationary syphon, as expected, remains in place as the dryer cylinder

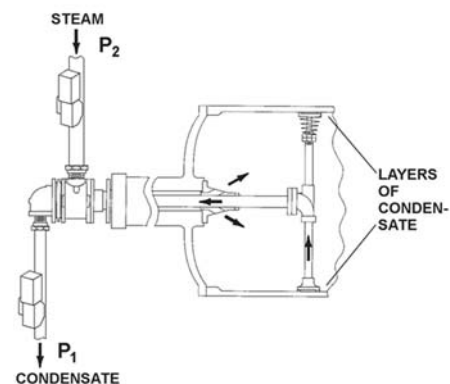

Figure 13. The dryer (rotary) syphon assembly, inside of the cylinder, with the supply and inlet piping and the outlet piping

	Group			
	1st	2nd	3rd	4th
Inlet header P2, bar (psi)				
Stationary	0.4 (5.7)	1.1 (16.4)	1.9 (27.4)	2.6 (37.8)
Rotating	0.8 (11.6)	2.0 (28.3)	3.1 (45.0)	4.2 (61.6)
Outlet header P1, bar (psi)				
Stationary	0 (0)	0.7 (10.7)	1.5 (21.5)	2.2 (32.2)
Rotating	0 (0)	1.1 (16.7)	2.3 (33.4)	3.4 (50.0)
Differential Pressure P2-P1				
Stationary	0.4 (5.7)	0.4 (5.7)	0.4 (5.7)	0.4 (5.7)
Rotating	0.8 (11.6)	0.8 (11.6)	0.8 (11.6)	0.8 (11.6)
Machine speed = 1200 m/min (4000 fpm)				
Condensing load = 4400 lb/h				

Table 1. Typical steam pressures and differentials in four dryer groups on a machine

rotates. The intake end of the syphon (the 'shoe') typically extends into a groove in the dryer shell, from which it extracts condensate that is rimming the inside surface of the shell. A rotary syphon, on the other hand, turns with the dryer cylinder. A rotary syphon shoe is kept directly contacting the dryer shell inside surface. There are satellite feet to maintain the clearance from the shell. They may be bolted to the dryer or held in place with a spring.

The rotary syphon requires significant differential pressure in order to pull the condensate from the shell inner surface into and up the syphon pipe. A stationary syphon may use a scoop-shaped shoe which will assist in pulling the condensate up into the syphon tube as the condensate rotates around the shell, thus requiring less differential pressure to extract the condensate.

Stationary Syphon	Rotary Syphon
Pressure difference is needed for operation	
Condensate in puddle form	
Continuous condensate removal	Steam blowthrough when syphon is outside puddle
Condensate in rimming form	
Smaller blowthrough rate, ~12 %	Bigger blowthrough rate, 25-30 %
Dryers stopped while steam on	
Normal condensate removal	Steam blowthrough and condensate build-up in dryer unless the syphon in bottom position
Normal run immediately after start up	Condensate takes time to get in balance

Figure 14. Characteristics of stationary vs. rotary syphons

A stationary syphon will therefore require less steam to operate effectively. This potentially represents a significant cost savings, as seen in the following example:

Rotary syphon: 20% blowthrough

- $40 \text{ dryers} * 0.2 * 350 \text{ kg/cylinder} * 8000 \text{ hr/yr} * 8.4 \text{ EUR/ton} = 188,160 \text{ EUR/year}$

Stationary syphon: 10% blowthrough

- $40 \text{ dryers} * 0.1 * 350 \text{ kg/cylinder} * 8000 \text{ hr/yr} * 8.4 \text{ EUR/ton} = 94,080 \text{ EUR/year}$

The difference of 94,080 EUR/year definitely gives the advantage to the stationary syphon. (Note that this does not fully apply depending on how efficient the existing steam system is.)

There are other fundamental differences between the stationary and rotary syphons stemming from their construction, implementation and operation. These are shown in **Figure 15 (next page)**.

Valves

Due to elevated temperatures metal seated valves are used in this process. The valves used should provide certain minimum tightness levels. The steam valves have to close during sheet breaks or for other short shut down reasons. Elevated temperature in the dryers may damage the fabrics when the dryers are not turning. Leaking valves can cause dryers to flood with condensate which harms the re-start and causes problems to the machine drives.

Valves in a steam system need to fail-closed or fail-open during power outages to protect the system depending on where they are used. The valves use spring-to-open or spring-to-close actuators to ensure the system is protected.

In general, butterfly valves are used for low pressure drops and conditions where the valve turndown is not very high as this is a very cost effective valve. When higher turndown and medium pressure drops are required segmented ball valves are the cost effective choice with great performance. Higher pressure drops and severe service applications move towards the Finetrol and rotary globe valve series. Segmented ball, Finetrol and rotary globe valves all have the option of Q-Trim noise attenuation for applications where the flow noise will destruct the valve.

The basis weight and steam consumption of board machines must often be changed in large increments during the operation. The valves used for control purposes must provide a good controllability (rangeability). V-shaped segment type valves are used commonly. (Calculate the noise generation in case of elevated pressures.) Q-Trims are frequently used.

Condensate tank

The main functions of the condensate tank are: to separate blowthrough steam and condensate received from the dryer groups, to pump condensate to the main condensate tank and to guide flash and blowthrough steam to a thermocompressor, cascade group or residual steam condenser.

Figure 16 shows a condensate tank operating while running normally. During normal operation, the steam and condensate from steam groups flow to the condensate tank. One condensate pump is running with hand valves open. The standby condensate pump is stopped and hand valves open. Condensate is pumped to the main condensate tank, with a condensate level between 20 and 80%. The condensate level controller is in automatic mode and valves are controlled by the level controller. Blowthrough steam from steam groups and flash steam formed in the condensate tank is guided to a steam group with lower pressure or a thermocompressor for recirculation within the same group.

ADVANTAGES OF ROTARY SYPHON

- Firm and mechanically durable with correct dimensioning and installation
- Free positioning in the dryer cross direction
- Locating between dryer bars possible
- Does not require a condensate groove
- Lighter and simpler bracket

DISADVANTAGES OF ROTARY SYPHON

- Differential pressure and blowthrough steam requirement depends on the machine speed
- Generally not well suitable for a cascade steam system, especially if the available steam pressure is low (adjustment range for drying capacity remains reduced)
- Not suitable for new top-speed machines
- Condensate removal is not in operation when the machine is down, unless the siphons are in the bottom position (in fabric-driven dryers siphons do not keep the same position)
- Unloading water ballast is not always possible during machine run
- Several siphon sizes for one machine (2 to 3 different sizes)

Figure 15. Advantages and disadvantages of rotary (vs. stationary) siphons

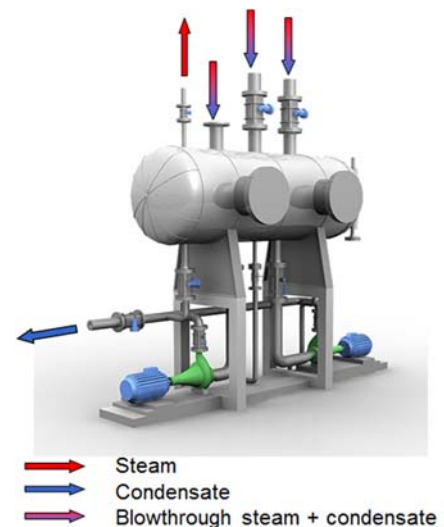

Figure 16. Condensate tank during a normal run situation

During a sheet break or warming situation, less condensate is flowing into the tank. Otherwise the situation is more or less the same as during a normal run. After a long shutdown the tanks should be emptied to remove the dirt from the system and the emptying valves must be checked and closed if found open.

The main targets of condensate tank level control are to ensure sufficient space for blowthrough flow and flash steam creation and to allow normal condensate flow variations. The level is measured with a level indicator and controlled with an exhaust valve, recirculation valve and condensate pumps. When the level is high, the recirculation valve is closed, the exhaust valve is open and pumps are running. When the level is low, the recirculation valve is open, the exhaust valve is closed and pumps are stopped.

Residual heat exchanger

The purpose of the residual heat exchanger is threefold: to condense the flash steam not used to heat cylinders, to maintain the pressure difference between the 1st steam group and the condensate tank (vacuum can be created for low pressure operation when steam condenses to condensate) and to work as a break steam condenser when paper is not on.

Cooling water circulation condenses the steam. Water circulation is controlled by water temperature to maintain sufficient pressure or vacuum. If the pressure difference setpoint is not achieved, the cooling water valve will increase or decrease the flow to achieve the requirement. Cooling water temperature must be about 20° cooler than condensate temperature.

Vacuum pump

The main job of the vacuum pump in a steam and condensate system is to remove air from the system and allow the heat exchanger to create the necessary vacuum level. The break valve controls the vacuum level.

Steam and condensate simulation – Steamux

Figure 17 shows the typical steam consumption of a fine paper machine. Valmet has developed a software tool for dimensioning of a new machine's steam and condensate system. The program, called Steamux, is also used to check the capacity and identify bottlenecks of existing machines. Thus, Steamux can guide the re-dimensioning of an existing machine's equipment, including condensate pumps, heat exchangers, control valves and piping. **Figures 18 and 19 (next page)** are examples of the simulations Steamux can provide.

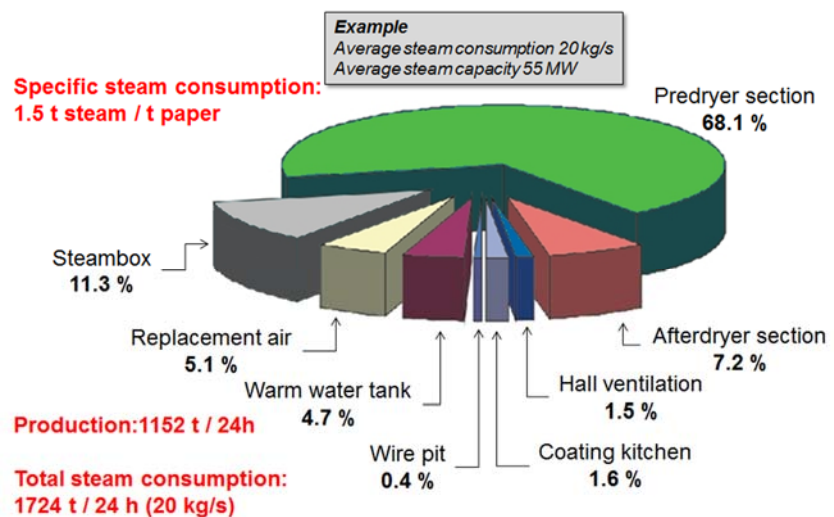

Figure 17. Typical steam consumption of a fine paper machine

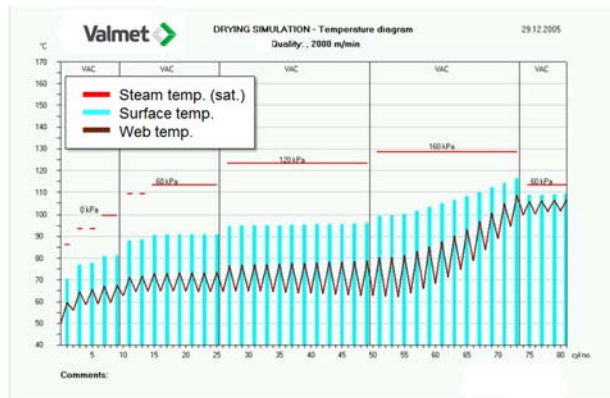

Figure 18. Steamux simulation – temperature diagram

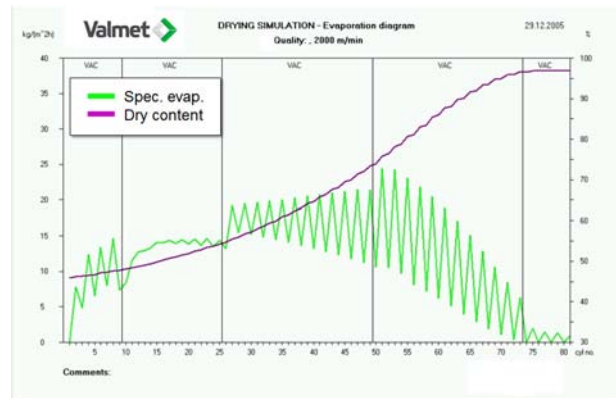

Figure 19. Steamux simulation – evaporation diagram

Maintaining air, steam & condensate systems

The following guidelines represent preventive maintenance actions which should be undertaken yearly. Annual service to the heating and ventilating equipment is usually done during the summer months when very little or no heating of the supply air is required. This ensures that the equipment is in good working condition for the coming heating season.

Completely check the condition and operation of all the components of the control system. Service these components regularly: instrument air filter (replace filter cartridge), pressure regulator valves, instrument air pressure gauges, temperature controller (check and calibrate), solenoid valves, damper operators (check and calibrate), steam valve (check and calibrate), air tubes and fittings, electrical wiring and connection.

Completely check the condition and operation of all the components of the steam and condensate piping system. Service these components regularly: gate valves and shut-off valves, strainers, check valves, pipe insulation, pipe and pipe fittings, pipe hangers, vacuum breakers, steam traps.

Check the condition of the complete ductwork system. Broken or corroded ductwork should be repaired or replaced. The distribution system should be re-balanced if required.

Check the condition of the duct hangers and repair where required.

Valmet steam and condensate products and services

Since 1961 Valmet in North America has been actively developing air systems products. This has continued through the acquisition of Beloit's technology and many of their engineers in 2000. The result of this blend of Valmet, Enerdry and Beloit expertise is a host of well-conceived and carefully implemented products and services to make pulp, board, paper and tissue lines run economically and efficiently.

Steam and condensate system audits

Valmet's advanced dewatering and drying solutions aim at improving paper quality and help enhance the production line's runnability, capacity, energy consumption, heat economy quality and speed. The scope of improvement can be exactly defined through a customized dewatering and drying survey.

Staying aware of operating conditions while saving time and money are 'hot' topics in multi-cylinder and Yankee dryer steam and condensate system maintenance. These systems benefit from regular audits to monitor performance.

Unfortunately, all system components will experience degradation in condition and performance over time. Only regular inspections can keep you aware of the operating condition of your multi-cylinder or Yankee steam and condensate system. Some potential indications of problems that can be detected by internal inspections include: improper controls adjustments and set points, excess energy use, steam erosion, steam leaks, corrosion, drying problems and unsafe operation.

Early detection of these problems and many others can yield tremendous savings in time and money, and possibly prevent harm to operating personnel. Valmet has the staff and equipment to quickly and accurately inspect your dryer steam system operation and provide a detailed analysis.

The benefits of a system audit are many, including: better productivity with limited investment; lower cost per ton produced; a more systematic way to develop operations, processes and equipment; long-term support by a reliable machinery and process supplier; and quick specialist assistance as needed.

A typical audit will include at least the following actions: inspection of external steam and condensate system, verification of operation, process calculations of the system, temperature measurements and troubleshooting of specific problems.

Steamfits and syphons replacement parts and kits

Bellows duplex and continuous service simplex and duplex steamfit/syphon assemblies that are properly maintained result in more productive drying time and substantially reduce downtime for carbon changes and other common maintenance.

Bellows duplex steamfits and syphons

The Beloit bellows duplex steamfit with rotating syphon was introduced in the early 1960s for use with enclosed gear dryer sections. Its success can be demonstrated by the fact that there are literally dozens of machines still using these steamfit / syphon assemblies. Their continued success can be assured with Valmet OEM duplicate replacement or upgrade parts.

The usual parts of the bellows duplex steamfit/syphons that will require replacement because of normal wear or operational damage are seen in **Figure 20**. Carbons, carbon supports, bellows, springs and packing rings are normal wear parts that are the most often replaced. The other itemized parts illustrated are equally important to the performance of the steamfit / syphon assembly as a whole. They will also require replacement from time to time, therefore they should be inspected and replaced as needed when replacing the normal wear parts.

The task of maintaining steamfits can be simplified by purchasing specific pre-assembled and normal wear parts, as maintenance part kits. The kits illustrated in **Figure 20** will not only save maintenance time, but will insure that you have the correct parts when they are needed.

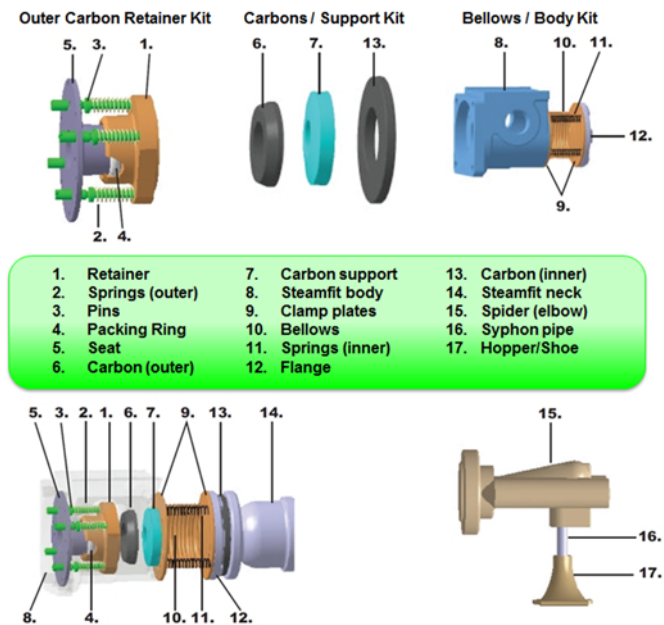

Figure 20. Recommended replacement parts and spare part kits for bellows duplex steamfit / syphon

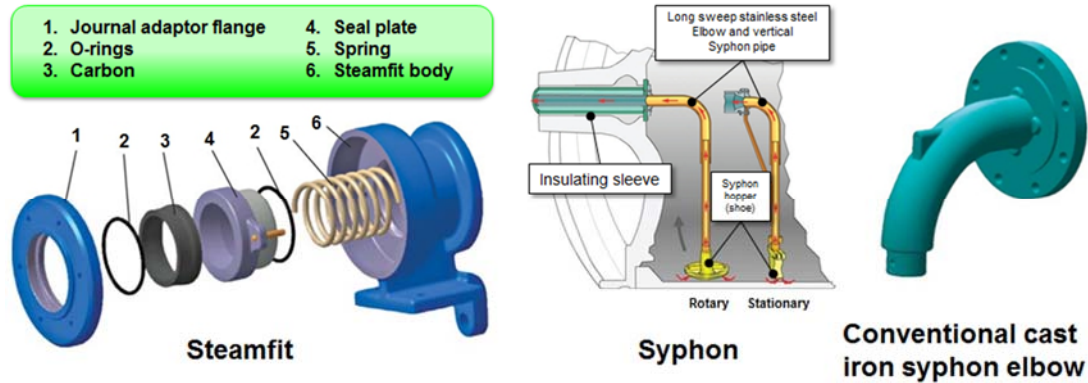

Figure 21. Recommended replacement parts for the CS simplex steamfit and syphon, and the traditional cast iron syphon elbow

Continuous service (CS) simplex and duplex steamfits and syphons

Often forgotten because of their obscure locations, CS simplex and duplex Beloit steamfit / syphon assemblies become critical components from a parts replacement standpoint, absolutely critical to uninterrupted operations. **Figure 21** illustrates the recommended replacement parts for the CS duplex steamfit and syphon.

The above illustration includes the recommended spares for a CS simplex rotating or stationary syphon (**Figure 21**, left) as well as the conventional cast iron syphon elbow (**Figure 21**, right). This older style cast iron syphon elbow used with some rotating syphon arrangements can be changed to the new 'quick change' long sweep stainless steel elbow and vertical syphon pipe (**Figure 21**, center). The conversion will reduce labor and downtime. The figure to the right shows the replacement parts for the CS duplex rotating (**Figure 22**, top) and stationary (**Figure 22**, bottom) syphons.

Genuine OEM parts provide value. Each part is made to exacting dimensional and material specification, to perform like original parts. Valmet stocks many of these steamfit system replacement parts.

Steam and condensate units

Dryer cylinders can be equipped with Valmet Steam and Condensate Units L and S for safe and trouble-free steam supply and leak-proof condensate removal. Condensate is removed through a stationary syphon.

Their sturdy design ensures efficient and vibration-free operation under all running conditions.

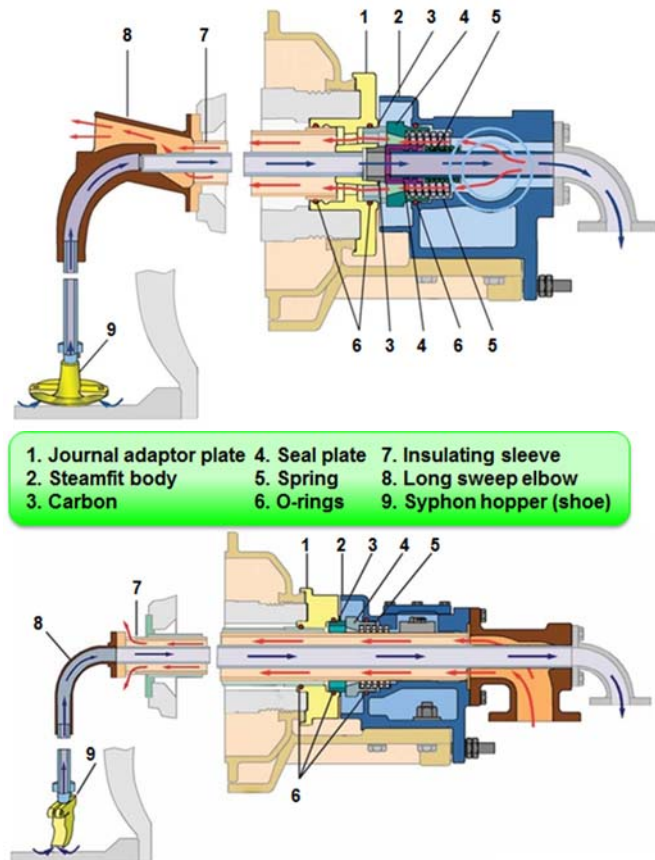

Figure 22. Recommended replacement parts for the CS duplex steamfit with rotating (above) syphon and stationary (below) syphon

The first bellowsless Valmet steam joint was taken into use in 1990. The first new machine equipped with bellowsless Valmet steam joints started up in November 1992. The same joint design is also available for water supply and drainage. Today, Valmet has about 2,000 references worldwide. Steam and condensate joints with stationary siphons are used in machines running 300-2,100 m/min and can be used with steam pressures of up to 11 bar (all three pressure classes).

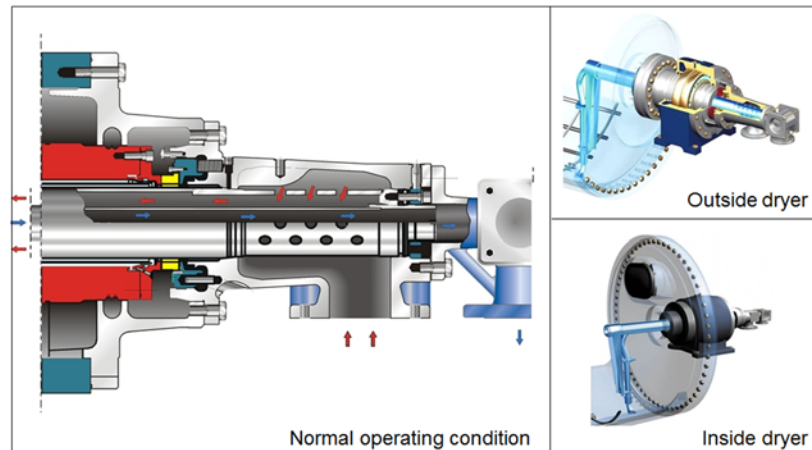

Figure 23. Steam and condensate unit

First, steam is lead into the steam joint through the steam inlet (**Figure 23**). Next, this steam flows through the holes in the steam pipe into the open space between the steam and condensate pipes. There it flows until it expands in the dryer, where it releases its thermal energy and condensates as water. This condensate is removed with a syphon from a condensate groove. Condensate flows through the syphon pipe and condensate pipe out of the dryer. Finally, we can see condensate escaping from the dryer by observing it in the flow indicator.

As can be seen in **Figure 23**, thermal energy is lead into the dryer through the journal. This causes thermal load to the journal and especially to the bearing when the dryer is heated (during the startup). It is at that point when severe bearing damage can occur if dryers are heated too rapidly.

The left side of **Figure 23** shows how the steam joint works in normal operating conditions. The dryer journal (shown in red) is rotating as well as the counterflange attached to the journal.

The other part of the steam joint sealing, the carbon ring (shown in yellow) is held in place by a retainer to the piston, and therefore remains stationary.

The pressure between the counterflange and the carbon ring is created with both helical springs and the steam pressure in the dryer.

When the steam pressure increases, more sealing pressure is created because the steam has an access behind the piston inside the joint. This helps the seal to hold because the more pressure there is in the dryer the more sealing pressure is needed.

With this kind of arrangement there is always at least a minimum pressure level between the sealing elements. This is created with the springs. Sealing pressure is also needed when the steam pressure is low or zero, in order for the carbon to seal. For instance if a dryer is operated below atmospheric steam pressure.

Valmet Steam and Condensate Unit L

Valmet Steam and Condensate Unit L, equipped with a stationary siphon, conveys steam to the drying cylinder and removes condensate efficiently while requiring little maintenance. This is the larger of the two steam joints, usually found on new machines. It is equipped with CARB bearings, multiple springs, the largest OD pipes and segment carbon ring.

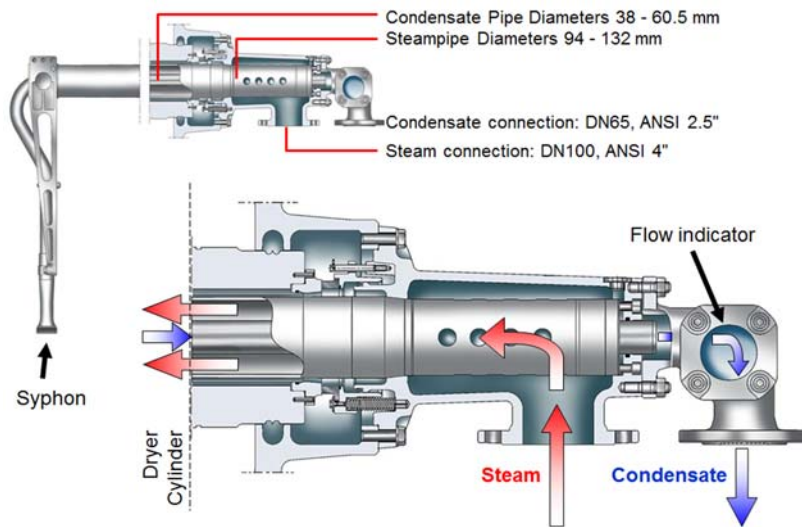

Figure 24. Valmet Steam and Condensate Unit L

is used so that condensate removal rate can be monitored from outside. If the condensate flow rate is not normal, operating personnel will notice that there are problems in the way the dryer is operating. There are several configuration options available to suit different application needs: steam unit, condensate unit, steam and condensate unit, and water joint.

Sealing pressure between carbon ring and counterflange is created with multiple springs and with steam pressure in the dryer. Dimensions with this joint design are larger than with Valmet Steam and Condensate Unit S, therefore both steam and condensate pipes can be larger.

Valmet Steam and Condensate Unit L provides tools to optimize your process, with steady condensate removal and exact management of paper web edge areas thanks to the adjustable syphon clearance. There is effective elimination of steam and air leaks through new, wear resistant seals and elimination of vibration through a rigid syphon support system. The design is sturdy and corrosion resistant and bearing damage is prevented by the insulating sleeve, which keeps the lubrication oil temperature stable. Also, condensate removal and carbon seal condition are easy to observe.

Valmet Steam and Condensate Unit S

Valmet's new steam and condensate unit, Valmet Steam and Condensate Unit S (**Figure 25**) is designed to ensure trouble-free operation with minimum maintenance. Also, equipped with a stationary syphon, this 'small' steam joint uses one large spring, smaller OD pipes and segment carbon ring. It is used for dryer section modifications and on those occasions when the larger DriCombi steam joint will not fit into the

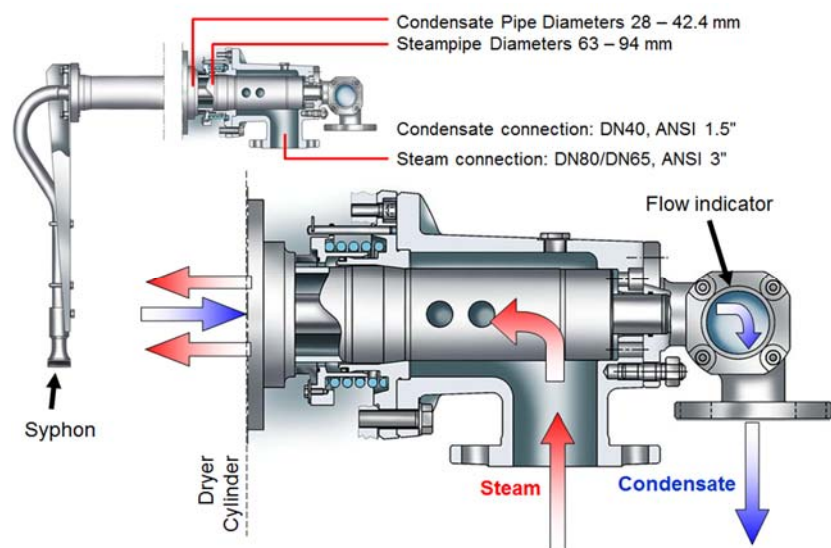

Figure 25. Valmet Steam and Condensate Unit S

The unit provides the efficient elimination of steam and air leaks, and is not sensitive to vibrations. Steam (**Figure 24**, red arrows) flows through a steam supply connection to the joint, from which it passes into a fixed steam pipe leading to the drying cylinder, where it heats the dryer and condenses to water. Condensate (**Figure 24**, blue arrows) is sucked into a stationary syphon and evacuated through a separate condensate pipe fitted inside the steam pipe. Condensate passes through a flow indicator which

application. Valmet Steam and Condensate Unit S is smaller and lighter than Valmet Steam and Condensate Unit L - but can be used with the same steam pressures (up to 11 bar).

Valmet Steam and Condensate Unit S functions in the same manner as Valmet Steam and Condensate Unit L, with the exception that sealing pressure between carbon ring and counterflange is created with a single spring and with steam pressure in the dryer. Dimensions with this joint design are smaller than with Valmet Steam and Condensate Unit L, therefore both steam and condensate pipes are smaller.

Valmet Steam and Condensate Unit S has several more benefits, in addition to its main function, safe and trouble-free steam supply and condensate removal without any leaks. Steam blowthrough rate is minimized with a stationary siphon, which is the most economical way to remove condensate. The adjustable siphon tip enables manual temperature control in cylinder edge areas similar to DriCombi.

Installation and service is easy due to lightweight split-in parts and minimized maintenance requirements. Other benefits are similar to those of the Valmet Steam and Condensate Unit L.

Dryer bars

Valmet Dryer Cylinder Bars (Figure 26, top), are U-profiled low-carbon steel bars that are fixed to the inside surface of the cylinder shell using special mounting straps designed to permit thermal expansion. The length of the bars is optimized to provide the most even surface temperature possible.

Valmet Dryer Cylinder Bars improve the transfer of heat through the shell by breaking up the film of condensate forming inside the cylinder shell (Figure 26, bottom). They boost the energy efficiency of dryer cylinders and also improve sheet moisture profiles through more uniform dryer surface temperatures (Figure 27).

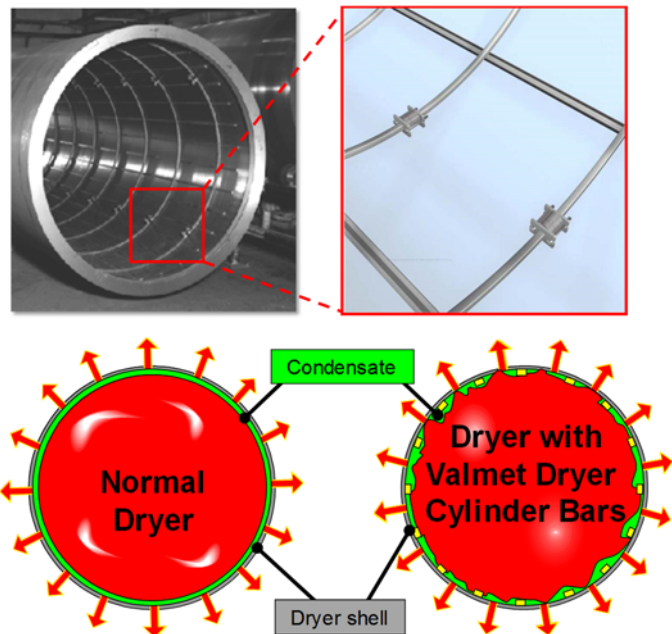

Figure 26. Valmet Dryer Cylinder Bars (top) break up the rimming condensate (bottom right), providing more even moisture profiles and increasing energy efficiency.

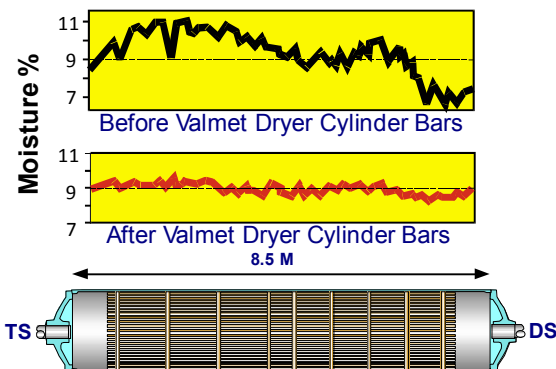

Figure 27. Example of improvement on newsprint machine moisture profiles

Dryer cylinder insulation sleeve

The insulation sleeve (Figure 28) is made of steel and is assembled in a dryer journal. There it forms an empty

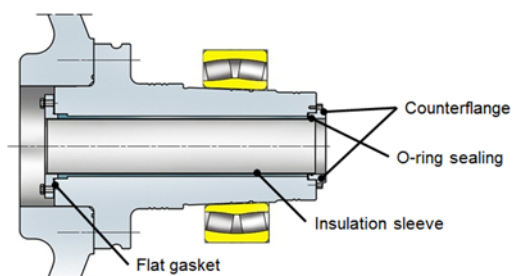

Figure 28. An insulation sleeve protects bearings from failure.

(insulating) space between the journal bore and the steam inside the dryer. This reduces the thermal energy conducted from steam to the journal (and from there to the bearing). Reduced thermal induction reduces the thermal expansion of the journal, which reduces the stresses in the bearing inner race. This also helps keep the bearing operating temperature lower.

If no insulation sleeve is used, typically either the clearance in the bearing goes to zero or the stresses in the inner ring will increase too much, resulting in bearing damage. An insulation sleeve is a simple and inexpensive way to reduce the probability of bearing failures.

The need for an advanced drying control system

The dryer section has three major areas that perform separate functions but are also directly related. Steam in the dryers adds heat to the paper to create the potential for evaporation. Process Air Systems provide the tempered air required for evaporation and removes the moist air from the dryer hood. Heat recovery systems capture the energy in the hood exhaust, to reuse in the process.

Runnability systems play an important role in maximizing the energy use in the dryers by improving the efficiency and are also part of the Process Air Systems. The dryer steam and condensate systems are also part of the heat recovery process through flash steam and condensate systems.

In short, the dryer section is the highest energy user in the paper mill and comprises a number of separate systems that need to be coordinated for efficient operation. At the same time the dryer section is typically the least understood process in the paper mill. Better understanding and control of drying provide the potential for energy improvements in the areas of: steam use, electricity use and heat recovery in the drying process.

An advanced control system provides the opportunity for improvement in the control of the drying systems to:

- Optimize the drying strategy
- Improve grade changes
- Improve threading and recovery with sheet break control logic
- Make system startups consistent
- Integrate all of the drying process controls during production.

Further potential of the new automation lies in the simplification of the drying control process, and tracking important variables for system evaluation and trouble shooting. To summarize, automation can take the guesswork out of drying control for a consistent and reliable operation.

DryingMaster control system – for an efficient drying section

Valmet's answer to the need for an efficient dryer section, which supports the machine operation, is the DryingMaster control suite (**Figure 29**). Using Valmet's process knowledge and automation expertise, this control suite was developed to integrate the control of the dryer section steam and condensate, process air and runnability systems, which results in a dynamic system control network, for the once separately controlled systems. DryingMaster will optimize the drying process for benefits in the areas of:



Figure 29. DryingMaster puts all the right tools in one place, allowing the operator to master the drying process.

- Reduced energy use
- Consistent drying methods
- Improved runnability
- High efficiency and productivity
- Manpower savings
- Process and energy benchmarking
- Remote diagnostics capabilities

With the modern machine requirements, this new automation has been developed to make the control of the dryer section easier, and more efficient.

All the right tools in one place

With DryingMaster mills have total automation of the drying process (**Figure 30**). This starts with automatic dryer startup for the steam and air systems. Then during production, the systems are optimized for the drying requirements and energy use. During system upsets and sheet breaks, there is logic to minimize energy use, ensure that the dryers are ready for sheet threading at all times, and minimize the sheet break recovery time.

Continuous energy monitoring creates the tools for benchmarking the drying performance, and allows for determining how well the wet end of the machine is performing in addition to the dryer section. The most important variable that needs to be tracked is the amount of work that the dryers are doing, which is shown as the evaporation load. Once we have the evaporation, a number of variables can be determined for the dryer section control and performance.

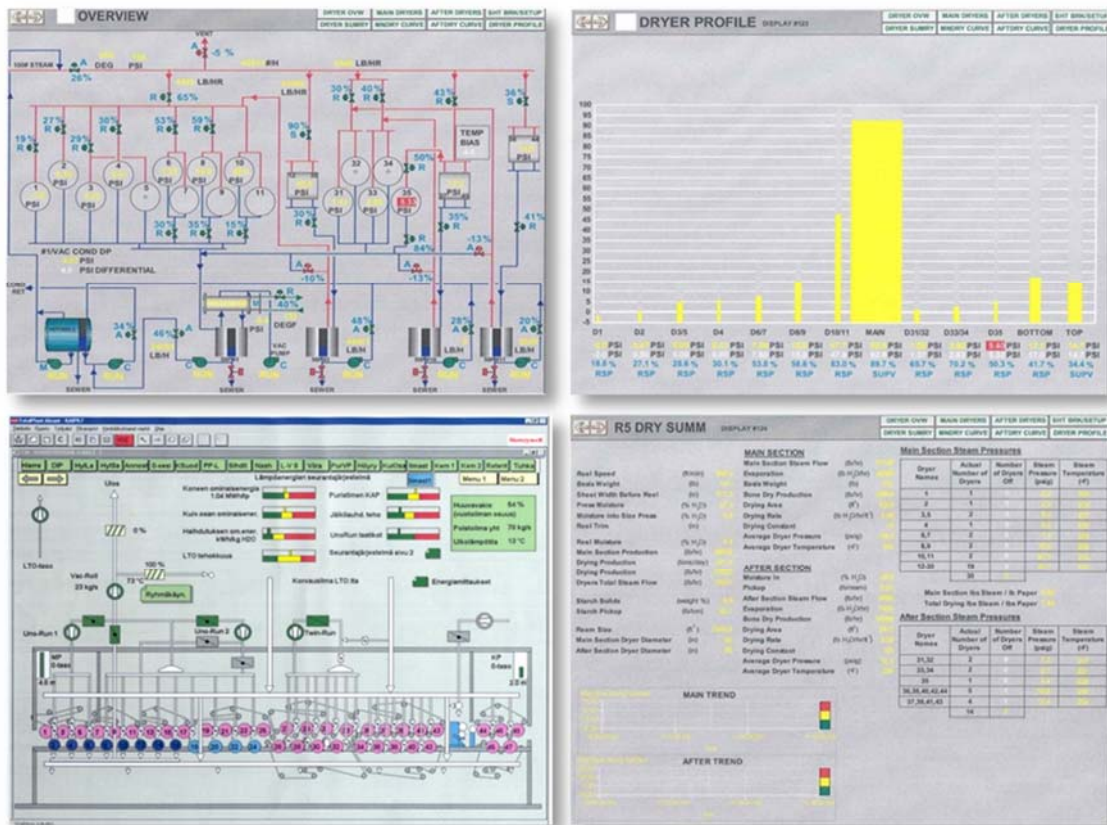

Figure 30. A good user interface for the drying process puts all information at the operators' fingertips.

This opens the doors to a number of opportunities in determining what needs to be done with the drying systems to become optimized for the operation. Knowing what the press moisture is for the current operating conditions provides the information required to make automatic controls accurate, repeatable, and reliable. (Note: This is calculated from the dryer steam use and used with historical data to determine the evaporation and press moisture. Hood humidity and exhaust flow measurements have been used in the past, but those systems require high maintenance in order to keep them in calibration. So steam use is now used as this system is clean and consistent for monitoring.)

One of the keys to good process control is to have a system that is correct for the application requirements. Good automation can help a poor system arrangement but, cannot by itself maximize the system effectiveness and efficiency.

With the proper system in place, you can have the best control and energy savings potential. All control components must be in proper working order for the system to work properly from the initial startup and forward. Once a benchmark has been set with proper equipment functionality, the system monitoring can provide the information required to be able to troubleshoot component malfunction.

Start with a good operator interface

To simplify the system controls we need to have a good operator interface. The graphical representation must be accurate and show the required information in as simple a representation that is clear and well communicated with the operator.

DryingMaster uses the measured information to calculate the important system variables for control and performance monitoring. With the calculated information, the system controls to maintain the necessary process variables that are determined by the operating conditions. It then optimizes the Steam and Air Systems control variables for good paper drying and efficient energy use.

And add in strategic tools

In addition to the energy aspects of the controls, there are also capabilities to automatically vary *how* the system is drying the paper, based on the grade and the production on the machine. This is done with Drying Strategies or Drying Curves, that vary how much steam is used in different dryer sections, for the production and grade requirements. As well, the hood is controlled to remove and supply the correct volumes of air for every drying requirement with Runnability Systems optimized for functionality and energy use.

Other DryingMaster controls that make for consistent performance and energy savings are:

- Automatic system start-up and shut-down sequences to ensure consistent and safe warm-up practices.
- Sheet-break turndown logic for the steam and air systems that maintains the dryer temperatures for good break recovery, and minimizes the energy use.
- Grade change, that automatically adjusts the steam pressures and temperature ramps, based on the weight change.
- Automatic curl control, that automatically adjusts top to bottom drying pressures based on the curl and drying requirement.
- Automatic differential pressure and/or blowthrough control based on syphon performance for energy management and reliable dryer drainage.
- Anti-choke thermocompressors logic where required to ensure efficient system operation.
- For the wet end and lead-in after dryers, the steam pressure ramping can be adjusted automatically for basis weight or grade, which relieves the operators of having to make this adjustment for grade changes.

- Stand-by mode for short shutdowns or wash ups that will minimize the energy with the system at idle.

Indicators help benchmark dryer operation

With the proper monitoring tools (**Figure 31**) it's possible to know where we are in terms of system performance and energy consumption. Measurements for energy monitoring and evaluation can include some or all of the following: dryers steam flow, dryers' condensate flow, condenser cooling water flow, hood air systems temperatures, hood air systems pressure losses and motor loads.

With the energy consumption measurements, DryingMaster will calculate the **process indicators** needed to benchmark the dryer operation, such as: evaporation, average press moisture, hood air flows, steam consumption and power consumption. (Note: There are some variables that need to be entered by the operator as the system does not monitor all the physical information in the dryers such as how many dryers are turned off. The variables that need to be entered are for system performance only, and the automation will still perform the necessary functions without this information, but the performance trends will reflect the true operation.)

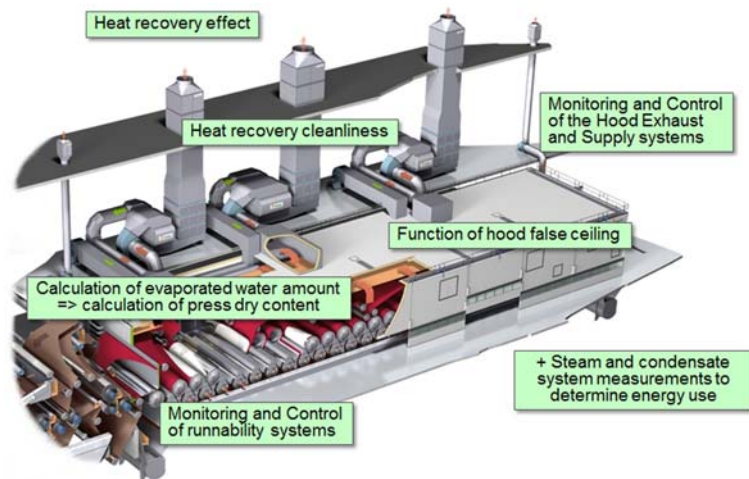

Figure 31. DryingMaster allows the operator to monitor and control the costs associated with the drying process.

Process indicators are used to determine the control requirements of the machine, such as how much hood air exhaust and supply air are required to meet the current drying conditions, while at the same time minimize the amount of steam and electricity that we have to put into the systems. Using the indicators as benchmarks also allows for detailed analysis of the system, and indicates whether you are in good operation or if there are areas that need troubleshooting or maintenance.

With the process indicators in place it is possible to calculate the **main indicators**. The main indicators are also benchmarked to tell us: what the dryer performance is, how well the wet end of the machine is working, specific energy use in the dryer section, how efficient the energy use is by production, how efficient the energy use is for the current drying load and the efficiency of the heat recovery. Finally, it provides a summary of all the measured variables from the dryer section, and the relevant process data from the gauging systems in one location in a simple-to-evaluate manner.

DryingMaster simplifies the drying process

When we look at the dryer section through the eyes of DryingMaster, the process becomes simplified. The measurements performed allow for real time evaluation of the system operation and gives the automation the capability of integrating the once separated control systems into one unified program. Further measuring allows for evaluation of energy use and recovered energy as well as complete optimization of the systems.

The presentation of the information shows us how much, where and the costs associated with the energy to determine if it is time to: change or clean felts, clean heat recovery elements, change filters or perform

system maintenance. Gathering and assembling this information into one place simplifies the evaluation and understanding of the systems.

Controls can be configured to suit your needs

From the hardware aspect DryingMaster can be installed as a supervisory system that communicates with an existing DCS or PLC. Or it can be a stand-alone control system for the dryer section only. The programming control capabilities can also be selected by the machine's requirements. The software can be separated for the dryer steam system and process air system with the base controls being:

- Automatic startup and shutdown
- Valmet machine direction moisture control
- Automatic sheet break logic for the steam system controls
- Automatic drying strategy for steam system controls
- Stand-by mode for scheduled short breaks or wash ups.

These base programming modules can be expanded to add in the process air and runnability systems for all the above noted capabilities. Advanced modules can also be added at the installation or at a later date when required or desired. The modules to consider are dependent on the drying requirements and are listed here:

- Advanced grade change logic for multi furnish producers
- multivariable coater dryer controls that can control up to nine different drying process variables at once.
- a press section moisture gauging system.
- FieldCare, which is a valve and instrumentation monitoring package
- Additional operating consoles
- Additional process control stations
- Engineering Tools software for control system expansion
- Remote services communication can be provided for review of the supervisory controls or stand alone systems.
- and services like Valmet's Help Desk with 24 hour, 7 day a week phone support.

Benefits of the DryingMaster control system

With the DryingMaster system installed, no matter what crew is on the machine, the drying control method will be consistent and the performance and energy use will be optimal. Quality of the paper will be consistent. Consistent drying strategy improves the sheet draw control and stability. Wet end steam pressures and temperature ramping reduces sheet picking and quality defects associated with hot dryers. Reliable methods of sheet break control stop the dryers from overheating, for improved sheet threading. Sheet break recovery is optimized for short sheet breaks. Automatic curl control will result in getting on- and maintaining on-specification paper for all grades and drying conditions.

With the dryer controls system optimized, energy can be saved through the system itself, and machine uptime will be maximized with the consistent dryer drainage and dryer section recovery capabilities. Startup is a breeze with the automatic programming, and allows for operators to work on other systems after the program is initiated. When the startup sequence is complete the machine is ready for sheet threading and making on-specification paper. Easy-to-understand graphics are intuitive and efficiently usable. Measuring and calculating the main system indicators provides a simple and quick method of evaluation.

Case Study: Total system approach

A newsprint machine with 305" trim added dryer bars to improve the profile. No other changes were made to the system. Dryer cylinder #11, a top UnoRun dryer, was tested and found to still have an unacceptable surface temperature profile. This was an example of not looking at the whole picture before making a process change.

Before calling in Valmet to perform a steam and condensate system audit, the dryer was equipped with spoiler bars, 1" rotary syphons, 1-1/2" condensate lines and flow visible in the sight glass. After Valmet presented the audit recommendations, the mill and Valmet made changes to several system components and then retested the dryer.

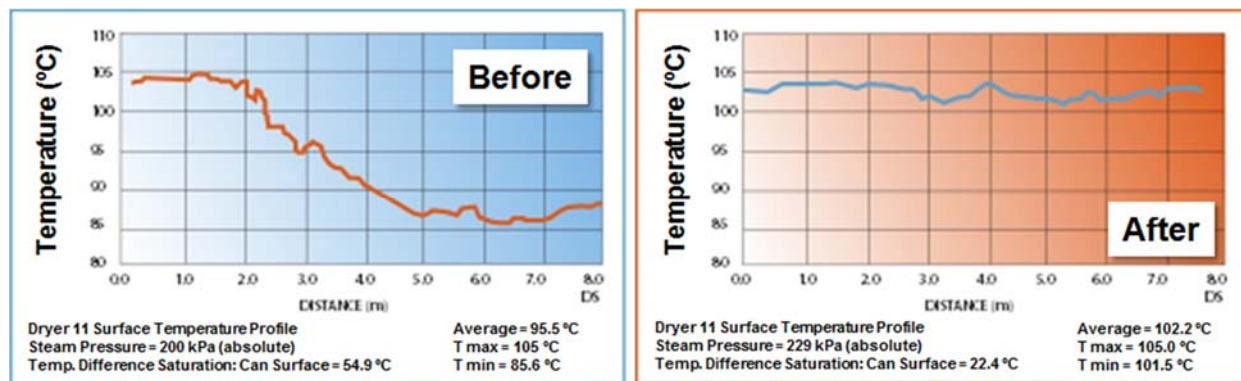

Figure 32. After a comprehensive audit, Valmet's total system approach to steam and condensate systems greatly improved this newsprint mill's profiles.

The new dryer setup included spoiler bars, 1-1/4" syphons, 3" condensate lines, lower differential pressures and an improved surface temperature to steam temperature difference. Valmet's total system approach provided positive results in performance (**Figure 32**).

Case Study: DryingMaster produces tremendous savings at newsprint mill

The mill operates a 1980s Valmet newsprint machine running at ~4500 feet per minute. The original cascade steam system with stationary syphons used 35 psig steam recovered from the TMP. The system was limited in flexibility, and all blowthrough steam was vented to the condenser.

The papermaking process suffered from MD moisture control problems. All steam groups were controlled individually. A small steam group (5 of 35 dryers) was used for moisture control. In addition, there was unacceptable lost time and production after startup. It would take from 20 to 40 minutes to achieve quality targets. After grade changes, the paper would typically be off-spec due to curl.

Opportunities from new resources

The mill identified a number of opportunities. First, there was excess hot water available from the pulp mill. This could be used to reduce the amount of hot water needed from the drying process. Second, there was cost effective 250 psig steam available from a sludge press boiler. The boiler was operated continuously to utilize the excess waste fuel. The mill was given a mandate to maximize the use of these resources in order to create energy savings.

How was DryingMaster implemented?

The mill contacted Valmet to initiate a review of their processes and make recommendations. From this review a recommendation was made to optimize the dryer section steam system. DryingMaster offered the best solution to meet the mill requirements both in terms of energy savings as well as product quality and production.

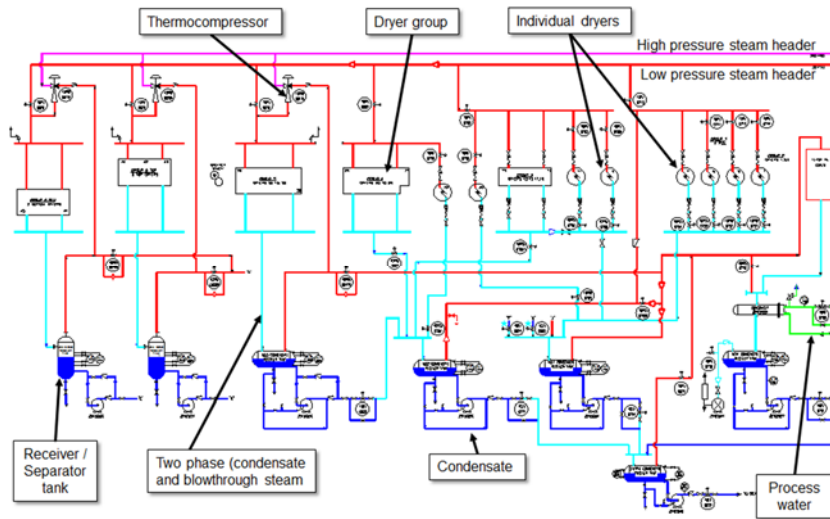

Figure 33. The steam system was modified to a hybrid cascade / thermocompressor arrangement.

The steam system was modified (Figure 33) to a hybrid system cascade / thermocompressor arrangement. The large main steam group was separated into two separate groups. The last steam group top and bottom dryers were separated to improve curl control. Some of the pressure controls were modified to maximize the system cascade flexibility.

In the automation area, the mill now enjoyed a completely controlled steam system, including automatic drying control for all grades as well as automatic grade

changes. Curl was adjusted automatically, with consistent control for all drying conditions. Differential pressure was controlled automatically, providing reliable condensate removal and efficient dryer energy use.

New programming logic was implemented for sheet breaks which maintained dryer temperatures during breaks and improved dryer sheet threading (Figure 34). A standby / felt wash mode was added, resulting in efficient energy use during downtimes. Startup and shutdown were automated as well. This ensured that dryers were ready to operate when needed, making startups more consistent while protecting the equipment and minimizing energy use.



Figure 34. The Sheet Break screen allows operators to monitor and control all essential drying process variables during automatic operations.

The mill started using a new Drying Performance Summary report (**Figure 35**) as part of the DryingMaster implementation. This included a real-time trend of drying performance allowing them to monitor energy use at all times. The evaporation load for the dryer hood and the sheet moisture content out of the press were calculated automatically. In addition, the Dryer Performance Summary provided benchmarking of the steam system under all operating conditions. This allowed the mill to monitor current operating energy costs and determine when to schedule maintenance of the dryer section or press section.

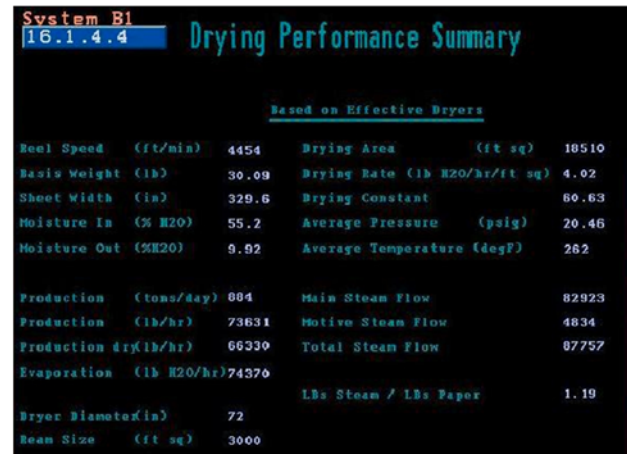

System B1 16.1.4.4 Drying Performance Summary			
Based on Effective Dryers			
Reel Speed (ft/min)	4454	Drying Area (ft sq)	18510
Basis Weight (lb)	30.09	Drying Rate (lb H2O/hr/ft sq)	4.02
Sheet Width (in)	329.6	Drying Constant	60.63
Moisture In (% H2O)	55.2	Average Pressure (psig)	20.46
Moisture Out (% H2O)	9.92	Average Temperature (degF)	262
Production (tons/day)	804	Main Steam Flow	82923
Production (lb/hr)	73631	Motive Steam Flow	4834
Production dry (lb/hr)	66339	Total Steam Flow	87757
Evaporation (lb H2O/hr)	74376	LBs Steam / LBs Paper	1.19
Dryer Diameter (in)	72		
Reel Size (ft sq)	3000		

Figure 35. The Drying Performance Summary provides real-time feedback of drying system operation.

What were the results?

Significant positive results were achieved based on the implementation of the DryingMaster system:

- Steam venting to the condenser was eliminated and hot water created by the steam system was minimized.
- The mill now had sufficient steam system flexibility for their drying process. They were able to achieve consistent drying results regardless of the grade being produced. They realized effective machine direction moisture control. Grade changes occurred automatically without going out of moisture specification.
- Curl control was now completely automatic. Sheet curl remained in-spec at all times - during normal operation as well as after grade changes. No curl adjustment was required.
- The new sheet break programs greatly improved machine operation in the dryer section during sheet breaks. This eliminated dryer wraps during threading, maintained good dryer temperatures for sheet threading, and eliminated steam venting during sheet breaks (for energy savings).
- The new automatic startup and shutdown programs also improved machine operation. Lost time during startups due to the dryer section was eliminated. The mill now used a consistent startup procedure that ensured good dryer temperature ramping and air removal from the dryers. Shutdowns were simplified.

The proof is in the bottom line!

Of course, all of the machine operation improvements would mean nothing if there weren't significant contributions to the bottom line. And this mill is an excellent example of what DryingMaster can do for your mill's profit margin. The mill reported a measured steam savings of 5700 pounds per hour. This, when combined with the improved dryer threading and new sheet break controls, produced the following results:

- \$240,000/year savings (at \$5 USD per 1000 pounds of steam)
- \$112,590/year production (as a result of a 2-minute reduction in break time/day)

The DryingMaster implementation resulted in over \$350,000 USD total project savings per year!

As seen in this case study, DryingMaster will minimize your energy use, help you get on-spec quickly and stay there, remove the guess work and variables for consistent operation and most importantly - maximize production and quality in your dryer section.

Case Study: Newsprint mill increases production and product quality with major dryer section rebuild

A newsprint mill wished to improve roll quality and productivity on their 30-year old #4 Dominion paper machine to be similar to that provided by their #5 10-year old Valmet machine. The dryer section produced difficult-to-control moisture profiles and had other operational problems.

Valmet Air Systems experts worked with mill personnel to perform a comprehensive audit involving in-mill diagnostic tests and verified that the dryer section had many issues that limited increasing production or further improving roll quality. Not least of these were an ineffective steam system that was inflexible and wasting steam as discussions with mill personnel and measurements proved.

The problem – inadequate steam and condensate system

The PM Superintendent observed there were moisture streaks near the syphon shoe. The shoes on the rotary syphons were positioned three fourths of the way toward the back side of the machine and they were difficult to adjust and maintain. Also, the moisture profiles changed over time. Part of the profile instability was due to air leaks in poorly sealed steam and condensate joints.

The dryer section was divided into only two steam groups. The first group used five heated top dryers (the bottom Unorun dryers were not heated). The remaining 41 dryers formed a very large second group, the group steam pressure being used for moisture control at the reel. This second group was frequently run at low pressure to avoid moisture issues. However, to maintain enough differential pressure to remove condensate from the dryers (using rotary syphons) some dryers were turned off. This resulted in moisture profile destabilization and excess steam being vented to the condenser such that up to 8000 lb of steam per hour would be wasted.

Since a high differential pressure was required to drain condensate with rotary syphons, the first dryer group could not be precisely controlled in order to create a gradual temperature increase and avoid picking. The first group of dryers also suffered from flooding. This resulted in severe machine vibration noticed by the operators and an hour of downtime to drain them. A large pressure and temperature difference between the first and second group caused picking and sheet breaks.

Formulating and implementing an action plan

Valmet formulated and presented an action plan including recommendations for a major rebuild of the steam and condensate system to make it up-to-date. The mill elected to proceed with a \$3.7 million machine improvement program that also included re-engineering the steam and condensate system, new stationary syphons and dryer bars in the dryer cylinders, changes to the approach piping, a new secondary screen, a new variable speed drive on the fan pump and a new online quality control system.

Orifice plates on the condensate lines were resized to match the condensate load and blowthrough amounts, allowing all dryer cylinders to use the same syphon vertical pipe. This provided more flexibility for speed changes and different grades, plus the reduced steam and condensate velocity in the larger diameter syphon pipes would decrease pipe erosion.

The new stationary syphons only required 2-4 psi (14-28 kPa) as compared to the previous rotary syphons which required 9-11 psi (62-75 kPa) pressure differential. The new joints fixed the air leakage that was causing poor profiles. The existing condensate headers were reused due to the lower pressures needed, further reducing installation costs.

Almost all dryer cylinders were upgraded with dryer bars to provide condensate turbulence and improve heat transfer. The dryer bars were easy to install, requiring only special spring loaded straps that allowed for thermal expansion.

The total system approach of the Valmet team resulted in dryer steam group reconfiguration to provide better control over temperature changes and moisture control by the quality control system. The new scenario uses five individually controlled wet end dryers and three independent steam groups in a hybrid cascade / thermocompressor configuration. New separators, pumps, transmitters and gauges were provided along with pre-piping and pre-testing the pre-assembled units.

Excellent results

After startup, the machine ran at higher speeds and required a lower steam temperature to dry the paper. The better heat transfer rate resulted in shell temperatures of the first four dryers which were 8-10 °C higher. Machine efficiency, machine speed and reel moisture levels have all increased beyond expectations, while total steam consumption has decreased dramatically (**Figure 36**). According to the PM Superintendent, the dryer section for PM4 was no longer an issue after the rebuild.

Summary

Effective design, implementation and maintenance of steam and condensate systems results in decreased energy use, more effective drying and a higher quality end product. The ability to distribute steam, regulate steam supply, control condensate removal, and ensure efficient re-use of flash steam and blowthrough steam in the dryer section are the primary functions of a steam and condensate system. The steam and condensate system may be cascade, thermocompressor or hybrid in design.

The steam and condensate system works with the dryer section hood and ventilation equipment, runnability systems, and heat recovery systems to provide the pulp, paper, board, or tissue maker with all the equipment necessary to ensure full control over drying performance and energy consumption of the dryer section. Valmet's total system approach combines all elements of Air Systems to maximize energy use and drying control at a mill. The DryingMaster control system is an example of this total approach saving hundreds of thousands of dollars per year.

This white paper combines technical information obtained from Valmet personnel and published Valmet articles and papers. Valmet provides competitive technologies and services to the pulp, energy and paper industries. Valmet's pulp, paper and power professionals specialize in processes, machinery, equipment, services, paper machine clothing and filter fabrics. Our offering and experience cover the entire process life cycle including new production lines, rebuilds and services. We are committed to moving our customers' performance forward.

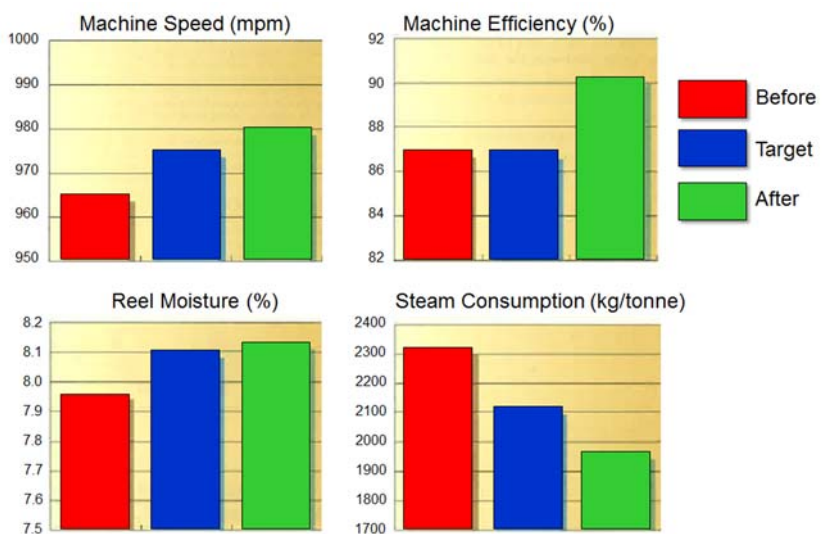

Figure 36. Rebuild results (green) exceeded the targets (blue) set by the mill.