

# Boiler Services Offerings – Power and Recovery North America

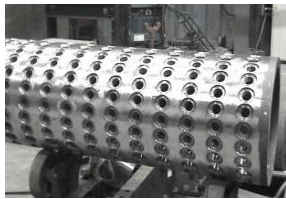

Spare Parts

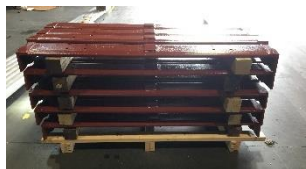

Fabricated Products / Tube Shields



Field Services



Pressure Parts

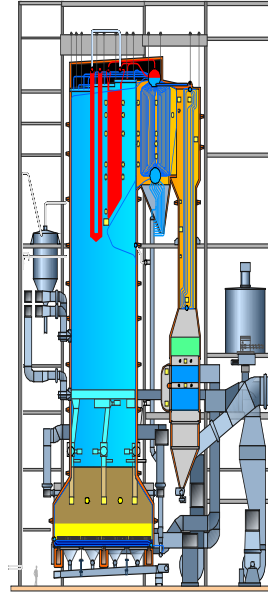

Rebuilds Upgrades

## Power & Recovery Contacts

**General Manager - Service**  
Dave Gadai 704-560-3575

**Power & Recovery NA - Sales Mgr.**  
Rod Horcoffi 704-877-9130

**Field & Outage Services Manager**  
Mike Ward 980-228-6659

**Fabrication**  
Ron Wharton 803-235-5760

**Boiler Tube Shields**  
Hanns VonSchmidt 304-518-1114\*  
Regina Tant 704-414-3449  
Valerie Pool 704-414-3444

**Outage Services / Boiler Cleaning**  
Rick Baxter 251-295-3532

**Spare Parts - Business Manager**  
Cameron Weir 704-219-1033

**Spare Parts / Customer Service**  
Tom Cross 704-258-7529  
Chad Daigle 704-414-3425  
Ron Cray 704-414-3506

**Project Management – North America**  
Tim Randall 920-540-4356

**Project Managers / Power & Recovery**  
Ron Reed 704-281-3073  
Jeremiah Yoder 704-408-6825

[www.valmet.com/napower](http://www.valmet.com/napower)  
[energyparts.NA@valmet.com](mailto:energyparts.NA@valmet.com)

1-888-574-0055 (24/7 Service)



# Solutions Offerings – Recovery, Lime Kiln, Biomaterials

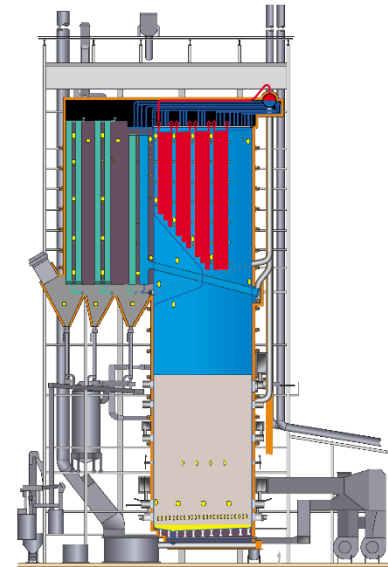
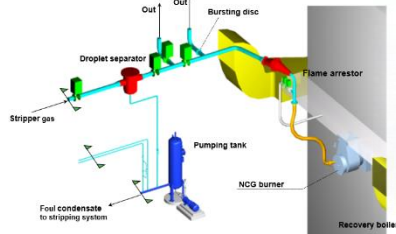

**NCG Solutions**

**Lime Kiln solutions**

**Evaporator solutions**

**LignoBoost**

**RB & PB Solutions**

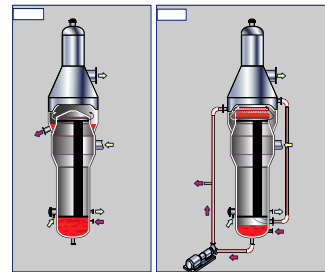
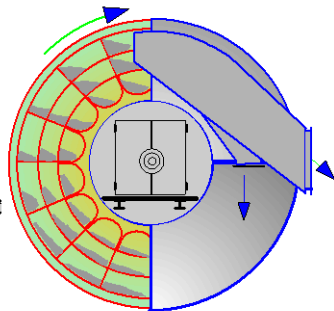
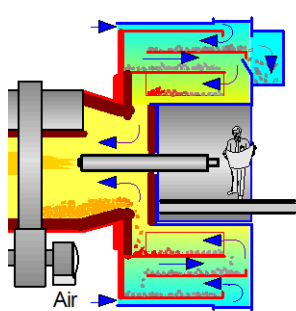

**Power & Recovery Contacts**

**General Manager - Service**  
Dave Gadai 704-560-3575

**Power & Recovery NA - Sales Mgr.**  
Rod Horcoffi 704-877-9130

**Field & Outage Services Manager**  
Mike Ward 980-228-6659

**Fabrication**  
Ron Wharton 803-235-5760

**Boiler Tube Shields**  
Hanns VonSchmidt 304-518-1114\*  
Regina Tant 704-414-3449  
Valerie Pool 704-414-3444

**Outage Services / Boiler Cleaning**  
Rick Baxter 251-295-3532

**Spare Parts - Business Manager**  
Cameron Weir 704-219-1033

**Spare Parts / Customer Service**  
Tom Cross 704-258-7529  
Chad Daigle 704-414-3425  
Ron Cray 704-414-3506

**Project Management – North America**  
Tim Randall 920-540-4356

**Project Managers / Power & Recovery**  
Ron Reed 704-281-3073  
Jeremiah Yoder 704-408-6825

**1-888-574-0055 (24/7 Service)**



# Common Links for Power and Recovery Services

## North America

- Main [Valmet Energy North America](http://www.valmet.com/NApower) BU ([www.valmet.com/NApower](http://www.valmet.com/NApower))
- Specific Product Links:
  - EEM » Mike Ward - [Field & Outage Services](mailto:mike.j.ward@valmet.com) (mike.j.ward@valmet.com)
  - EEM » Rick Baxter - [Chemical Cleaning Specialist](mailto:richard.baxter@valmet.com) (richard.baxter@valmet.com)
  - EEM » Mike Ward – [IBMACT Boiler Tuning](#)
  - EEM » Mike Ward – [Boiler Tube Scale Deposit Measurement Program](#)
  - AUP » Hanns VonSchmidt – [Boiler Tube Shields and Pressure Parts](mailto:hanns.vonschmidt@valmet.com) (hanns.vonschmidt@valmet.com)
  - AUP » Mike Ward – [Recovery and Power Boiler Enhancement & Safety Products](#)
  - AUP » Terry Troha – [Boiler Tubing](mailto:terry.troha@valmet.com) (terry.troha@valmet.com)
  - SPE » Ron Wharton – [Boiler Pressure Parts and Fabrication](mailto:ronald.j.wharton@valmet.com) (ronald.j.wharton@valmet.com)
  - ENP/EEU » Rod Horcoff – [Power & Recovery Boiler Project Solutions](mailto:rod.horcoff@valmet.com) (rod.horcoff@valmet.com)
  - ENP/EEU » Dave Gadai – [Power & Recovery Boiler Project Solutions](mailto:dave.gadai@valmet.com) (dave.gadai@valmet.com)

# Services & Products

## Energy Spare Parts & PCO (ESP)

- Tube Shields
  - Straight Shields
  - Curved (ID/OD) Shields
  - Economizer Shields
  - Drape Shields
  - 370° Shields
  - Tube Shield Clips
- Fabrication
  - Expansion Joints
  - Hand-Cuffs (tube alignment bars)
  - Wall Boxes
  - Support Brackets
  - Metso Minerals
    - Wobbler Bars
    - Feeder Flights
    - Leaf Segments
  - Environmental Equipment (Scrubber components)
  - U-Beam Channels
  - Tanks/Vessels
  - SS Process Ductwork
  - General Fabrication

## AUP / EEM

- Straight Tubing / Pressure Parts
  - Straight tubing
    - Cutting, end-preps, packaging
  - Pressure Parts
    - Loose tube bending
    - Bent openings
      - Spouts, air-ports, etc...
    - Small miscellaneous fabrications
      - panels, hand welding, headers
- Straight Tubing / Pressure Parts
  - Straight tubing
    - Cutting, end-preps, packaging
  - Pressure Parts
    - Loose tube bending
    - Bent openings
      - Spouts, air-ports, etc...
    - Small miscellaneous fabrications
      - panels, hand welding, headers
- Recovery Boiler Enhancement / Safety Products
  - Smelt Spouts
    - ShatterJets
    - Overlay, cooling-water connections
    - Spout hoods
    - Dissolving tank collars
  - Liquor Stations
    - Cutters
  - Port Rodders
    - Air-port nozzles
    - Cutters
    - Rebuilds



# Valmet - Energy Services

## Product Lines (North America)



### Boiler Components

- ASME Section I
- RB & PB Rebuilds & Upgrades (Any manufacturer)
- Direct replacement of boiler components.
- Pressure Piping
- Installation supervision



### Pressure Vessels

- ASME Section VIII
- CS & SS Applications
- Heat Exchangers
- Process vessels



### Tanks

- API 620, 650, 12 F
- Up to 1" thick CS & SS
- Condensate tanks
- Mix Tanks
- Dissolving tanks



### Recovery Boiler Parts

- Smelt spouts and spout plugs.
- Liquor spray stations.
- Liquor nozzles.
- Port rodders.
- Air port castings.
- Replacement pressure part openings.



### Tube Shields

- Leader in NA tube shield manufacturing for boiler tube wear protection.
- Manufactured from all boiler grade alloys for custom tube shields up to 3/8".
- Customized shapes to fit your needs.
- Extensive material stocking.
- Most orders Ship within 24 - 48 hours.



### Structural & Plate Fabrication

- AWS D1.1, D1.6
- Carbon, stainless and aluminum plate fabrication
- Specialty fabrication of heavy weldments
- Crusher bases
- Heat exchanger towers
- Custom Engineered fabrications
- Carbon steel plate fabrication
- Ductwork
- Expansion joints



### Stock tubing and plate

- Large inventory of composite tubing in Sanicro 38 & 304L
- Access to large supply of carbon steel and alloy boiler tubing
- Full line of RB spares (smelt spouts, gunners mates, liquor nozzles, air port castings, etc.)
- Membrane bar (WOL and Composite)

Full Service